

JOHANSON products are in diverse applications, encompassing but not limited to:

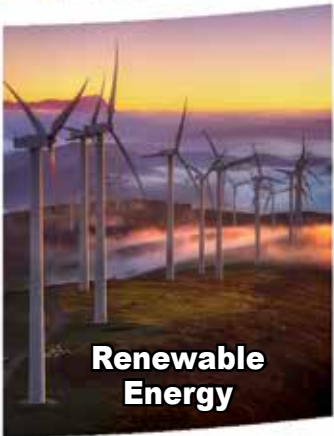
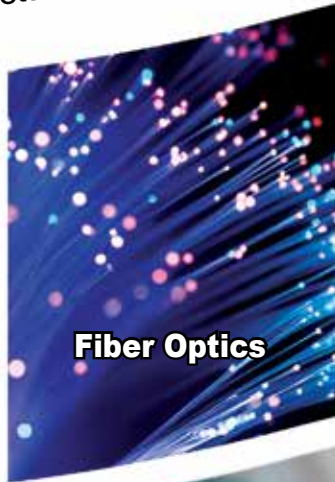

JOHANSON'S Mission

Our mission is to translate customer needs into quality electronic components, produced in factories that are models of excellence, supported by innovative service. With over 20 years of experience, Johanson can provide both standard and custom technology solutions tailored to customers specific RF/Microwave applications. Our software design tools (library of more than 20 dielectric materials & various metal systems), thin-film and thick-film manufacturing capabilities enable us to produce components that are ideally suited to customers specific needs.

Quality Policy

Johanson's quality engineering's structure is in line with modern quality principles, a vision, and support for quality. The utilization of advanced product/process quality planning (APQP) includes real-time statistical process control (SPC), design and process FMEAs with dynamic control plans, gauge R&R, and a web-based documentation systems.

"At Johanson, quality is not a department, it's a culture!"

Environmental & Management Policies

Johanson is committed to the prevention of pollution by complying with all local, state, and federal environmental pollution regulations, legal requirements, and obligations; developing environmental objectives by evaluating production activities; and continually improving the environmental management system to enhance environmental performance through periodic review of objectives and targets.



Throughout this catalog...

JOHANSON has made all efforts to ensure data that reflects the actual performance of the parts. Changes to substrates, mounting and matching will affect component performance. Customers must validate performance in their system. Additional application notes may be found on our web site.



Table of Contents

HIGH RELIABILITY SERVICES

- 06 High-Reliability Testing Information - Defense, Avionics & Space

PROTOTYPING KITS

- 07 Prototyping Kit Selection Guide

RF ANTENNAS

- 09 RF Antennas (Dual, & Triple Bands)

EMI X2Y FILTERS

- 12 EMI X2Y Filters

CAPACITORS

- 17 AC Power, SMT
- 18 AC Safety, SMT
- 21 Automotive Grade Mid-Voltage High Capacitance
- 24 High Reliability, SMT
- 26 High Voltage, SMT, 250 - 6,000
- 28 High-Q, Ultra-Low Loss, SMT
- 41 Power High-Q, & High Voltage Assemblies
- 42 High Temperature
 - 42 SMT Chips 200°C Rated
 - 44 Radial Leaded 200°C Rated
- 46 Radial Leaded (Switchmode)
- 48 Radial Leaded (High Voltage)
- 50 LASERtrim®
- 54 TANCERAM®
- 56 Single Layer (SLC)
- 76 (SMPS) Switchmode® Stacked
- 79 CapStrate® = Bulk Capacitance Embedded in High k Ceramic Substrate
- 84 Custom Shape Bulk Capacitance (Custom Solutions)

RF INDUCTORS

- 85 Ceramic Inductors
- 89 WireWound Inductors

INTEGRATED PASSIVE COMPONENTS

- 95 IPCs by Category & Application Bands
- 96 Complete RF Front End Solution
- 97 Baluns
- 100 Baluns Filter Combinations
- 101 Band Pass Filters
- 107 Couplers
- 108 Diplexers, & Triplexers
- 110 High Pass Filters
- 111 Low Pass Filters
- 112 Power Coupler
- 112 Power Dividers

PLANARS

- 113 Planar - Array Caps for EMI Filtering
- 114 Circular, Rectangular & D-Sub-Miniature Arrays
- 118 Discoidal Capacitors Arrays

SUBSTRATES

- 116 Substrates - Thin Film Patterned

About JOHANSON

At JOHANSON

We are committed to supporting design engineers. This catalog features advanced components, and solutions to support design innovations.

Our broad product offering includes, but not limited to:

- RF Antennas
- EMI X2Y Filters
- Capacitors for both RF and Power Applications
- RF Inductors
- Integrated Passive Components
- Planars
- Substrates









We also recognize that every project is unique, which is why we provide custom solutions to match specific requirements. Our team is prepared to collaborate & deliver ideal solutions for unique design requirements.

JOHANSON'S History

- ISO-9100 Facilities
- ISO-9000 Facilities
- Automated SPC Network System
- Complete Lot / Material Traceability
- Advanced Material Analysis Capability
- Continuous Quality Training of Work Force



Designer's Tools

RESOURCE TYPES	RESOURCE DESCRIPTIONS & LINKS
<p>Application Note</p> 	<p>Title: S-Parameter Measurements Application Note Link: https://www.johansontechnology.com/s-parameter-app-note</p>
<p>Download</p> 	<p>Title: Designer Libraries Link: https://www.johansontechnology.com/designer-libraries</p>
<p>Technical Booklet</p> 	<p>Title: Understanding Chip Capacitors Link: https://www.johansontechnology.com/docs/28/understanding-chip-capacitors.pdf</p>
<p>Modeling Software Tools</p> 	<p>Title: Avago AppCAD Understanding and Learning the fundamentals of Chip Capacitors Link: https://www.johansontechnology.com/downloads/avago-appcad/</p>
	<p>Title: JTISoft Link: https://jtisoft.johansontechnology.com/</p>
<p>Tool</p> 	<p>Title: Chip Antenna Selection Guide Link: https://www.johansontechnology.com/chip-antenna-selection</p>
<p>Tool</p> 	<p>Title: Chip Antenna Mounting and Tuning Techniques Link: https://www.johansontechnology.com/tuning</p>
<p>Tool</p> 	<p>Title: S21 Plotter (for EMI X2Y Filters) Link: https://s21plotter.johansondielectrics.com/</p>
<p>Design Guide</p> 	<p>Title: CapStrate® Design Guide Link: https://www.johansondielectrics.com/downloads/johanson-capstrate-design-guide.pdf</p>
<p>Design Guide</p> 	<p>Title: Thin Film Design Guide Link: https://www.johansontechnology.com/downloads/johanson-thin-film-design-guide.pdf</p>



Services:

- Mil-Standard
- Custom Products
- Quality Certifications
- Environmental Testing
- RF Testing Capabilities
- Special Testing Capabilities

Johanson provides both Mil-Standard screening and COTS Ceramic Chip Capacitors, RF Passives, RF Inductors to High-Reliability applications globally.

In addition to manufacturing, our Camarillo facility has a complete High-Reliability department with in-house testing capabilities.

Analytical Testing:

- XRF Analysis
- SEM Inspection
- Solderability Testing
- Radiographic Inspection
- Destructive Physical Analysis (DPA)
- Acoustic Microscopy (Sonoscan) Inspection

Electrical & Mechanical Inspections:

- Hot IR Testing
- Full Data on Serialized Units
- Temperature Voltage Coefficient (TVC)
- Temperature Capacitance Coefficient (TCC)
- 100% Visual Inspection (Mil 883 Class K or S Options)
- 100% Electrical TesCap, DF, IR, DWV, Voltage Breakdown

RF & Microwave Testing Expertise:

- Vector Network Analyzer (VNA) Measurements
- Resonant Line Measurements for ESR at frequency

Modeling Software:

- Avago App CAD
- JTISoft

Designer Guides:

- S-Parameter Files
- AWR MWO
- Eagleware Gensys
- Keysight ADS
- Modelithics Microwave Global Models

Environmental Testing:

- Steam Age
- Life Testing
- Bend Testing
- Humidity Testing
- Wire Bond Testing
- Moisture Resistance
- Temperature Cycling
- HALT / HASS Testing
- Thermal Shock Testing
- Shock / Vibration Testing
- Resistance to Solder Heat
- Shear Test / Bond Pull Test
- Burn In / Voltage Conditioning
- Class H, K or S Element Evaluation

RESOURCE ► Contact Our Engineers for Your High-Reliability Requirements:
<https://www.johansontechnology.com/ask-a-question>

Military Aerospace High-Reliability:
<https://www.johansontechnology.com/products/military-aerospace-high-reliability/>

Prototyping Kit Selection Guide

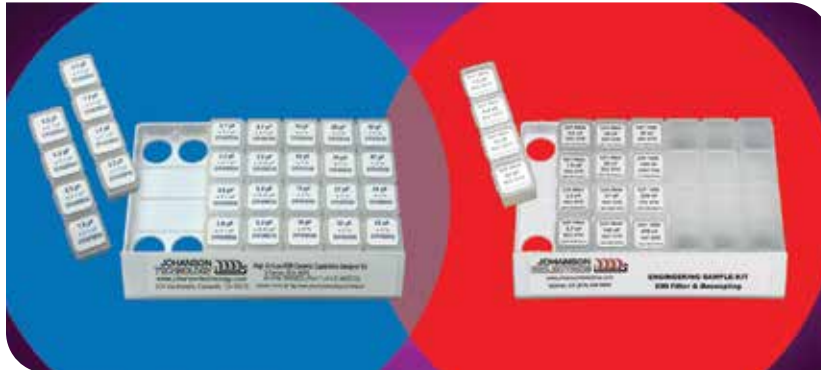

Features:

- Multiple capacitance and tolerance values included in each kit.
- Multiple case sizes available.

Category	Type	Product	Size/Voltage	Kit P/N	Series	Kit Description
Capacitor	MLCC	High Voltage	1000 VDC	S-1KV	HVS	1000 VDC Ceramic Chip Capacitors
Capacitor	MLCC	High Voltage	2000 VDC	S-2KV	HVS	2000 VDC Ceramic Chip Capacitors
Capacitor	MLCC	High Voltage	500 VDC	S-500	HVS	500 VDC Ceramic Chip Capacitors
Capacitor	MLCC	Safety Rated	UL Cert	S-SY2	HVS	X1/Y2 Safety Certified Ceramic Chip Capacitor
Capacitor	MLCC	Safety Rated	UL Cert	S-SY3	HVS	X1/Y3 Safety Certified Ceramic Chip Capacitor
Capacitor	MLCC	High-Q	0201	S201DL	L-Series	0201 L-Series Capacitors
Capacitor	MLCC	High-Q	0201	S201TL	L-Series	0201 L-Series Tuning Capacitors
Capacitor	MLCC	High-Q	0402	S402CHI	C-Series	0402 C-Series Capacitors, High Values
Capacitor	MLCC	High-Q	0402	S402CLO	C-Series	0402 C-Series Capacitors, Low Values
Capacitor	MLCC	High-Q	0603	S603CHI	C-Series	0603 C-Series Capacitors, High Values
Capacitor	MLCC	High-Q	0603	S603CLO	C-Series	0603 C-Series Capacitors, Low Values
Capacitor	MLCC	High-Q	0805	S805CHI	C-Series	0805 C-Series Capacitors, High Values
Capacitor	MLCC	High-Q	0805	S805CLO	C-Series	0805 C-Series Capacitors, Low Values
Capacitor	MLCC Non-Magnetic	High-Q	0805	S805DG	G-Series	0805 MLC Capacitors, Non-Magnetic
Capacitor	MLCC Non-Magnetic	High-Q	0805	S805TG	G-Series	0805 MLC Capacitors, Tuning
Capacitor	MLCC	High-Q	1111	S111DVE	E-Series	1111 E-Series Capacitors
Capacitor	MLCC	High-Q	1111	S111TVE	E-Series	1111 E-Series Capacitors, Tuning
Capacitor	MLCC Non-Magnetic	High-Q	1111	S111DUE	E-Series	1111 E-Series Capacitors, Non-Magnetic
Capacitor	MLCC Non-Magnetic	High-Q	1111	S111TUE	E-Series	1111 E-Series Capacitors, Tuning
Capacitor	Single Layer	Single Layer	GBBL	GBBL	Broadband SLC	Broadband SLC Capacitors
Capacitor	Single Layer	Single Layer	SLC	SLC	Standard SLC	Standard SLC Capacitors

Prototyping Kit Selection Guide

Category & Type	Product	Size/ Voltage	Kit PN	Series	Kit Description
IPC	Inductors & RF Components	0402 & 2.45GHz	2450L/C402D	S-Series	Application Specific Integrated Passive
IPC	Inductors & RF Components	0603 & 2.45 GHz	2450L/C603D	S-Series	Application Specific Integrated Passive
IPC	Inductors & RF Components	0402	5500L/C402D	S-Series	Application Specific Integrated Passive
IPC	Inductors & RF Components	0603	5500L/C603D	S-Series	Application Specific Integrated Passive
IPC	Capacitors & RF Chip Inductors	0402	IOT-L/C402D-1	S-Series	Internet of Things ISM Development

"Not sure which kit to select?"

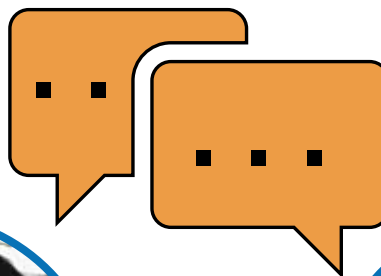

Ask JOHANSON engineers today!



Ask a question! <https://www.johansontechnology.com/ask-a-question>

Visit our websites for more information. . .

<https://www.johansontechnology.com>

<https://www.johansondielectrics.com>

RESOURCE ► High Voltage/Safety Rated Capacitor Kits:
<https://www.johansondielectrics.com/high-voltage-kit>

EMI Filter Kits:
<https://www.johansondielectrics.com/emi-kit>

High-Q Capacitors, RF Inductors, Single Layer & Application-Kits:
<https://www.johansontechnology.com/products/rf-component-prototyping-kits/>



RF Antennas (Dual, & Triple Bands)

World Leader in
Chip Antenna Design 



**For Smart Homes, IoT,
Wearables, Automotive & More**

Johanson chip antennas are constructed using a variety of techniques, including monopole, dipole, folded loop, inverted-F, and inverted L-designs. These are made using Low Temperature Co-Fired Ceramic technology which enables them to have great detuning resilience and extreme temperature stability (~2ppm) behavior.

Features:

- Various Bandwidth Within 430MHz to 10GHz
- Smallest Form Factor Chip Available
- AEC-Q200 Automotive Qualified (As Required)

Benefits:

- Better resilience than PCB and whip Antennas
- Guaranteed resonance in mass production
- Design Review Available (for qualified customers)
- **OUR LAB SERVICE INCLUDES:**
RF antenna engineer validating your prototype, complete RF tuning (with part numbers provided), anechoic chamber OTA (over-the-air) gain, efficiency, and radiation plots, & any last design optimization observations



"Not sure how to
select the right
antenna for your
product design?"

Start with the . . . Antenna Selection Guide Tool

An interactive, easy to use, step-by-step tool to help you get the correct antenna chip part number, for your project.



CHIP ANTENNA SELECTION GUIDE ► <https://www.johansontechnology.com/chip-antenna-selection>

Common Applications:

- | | | |
|----------------------------|----------------------------|--------------------------------|
| • IoT (Internet of Things) | • Tag, Tracers, iBeacon | • Wi-Fi Access Points |
| • Wi-Fi 6E and Wi-Fi 7 | • Home Automation/RF Locks | • Chipset Specific FEMs |
| • Amazon Sidewalk | • Advanced Thermostats | • Portable Positioning Modules |
| • Wearable Devices | • POS/Payment Systems | • Vehicle/Insurance Tracking |
| • Portable Audio | • Telematics | |
| • Sensors | • In-Vehicle Wi-Fi | |

TUNING SERVICE ► <https://www.johansontechnology.com/tech-notes/chip-antenna-design-assistance-tuning-and-characterization-services/>

RF TEAM SERVICE ► <https://www.johansontechnology.com/ask-a-question>

RESOURCE ► <https://www.johansontechnology.com/products/antennas/antennas/>



RF Antennas (Dual, & Triple Bands)

World Leader in
Chip Antenna Design 

Part Number	Frequency (MHz)	Peak Gain (dBi)
0433AT62A0020001E	423-443	-4.0
0433AT62A0020002E	423-443	-4.0
0490AT62A0040001E	470-510	-3.0
0783AT43A0008001E	779-787	-2.0
0830AT54A2200001E	700-800 1700-2100 824-960 1710-2690	2.0 2.0
0868AT43A0020001E	858-878	1.0
0868AT43A0020002E	858-878	1.0
0900AD47A2450001E	858-928 2400-2480	-1.0 2.5
0900AD54B2450001E	858-928 2400-2480	1.1 1.7
0900AT43A0070001E	858-928	-0.5
0915AT43A0026001E	902-928	-1.0
1227AT45A0042001E	1206-1249 (±21MHz)	1.0
1575AT43A0040001E	1561-1602	-1.5
1575AT44A0010001E	1570-1580	0.5
1575AT54A0010001E	1570-1580	1.3
1582AT54A0045001E	1560-1605	1.5
1600AT45A0040001E	1580-1620	0.0
1905AT45A0050001E	1880-1930	0.5
2000AT18A0075001E	1965-2040	0.3

Part Number	Frequency (MHz)	Peak Gain (dBi)
2440AT62A0085001E	2400-2485	3.5
2440AT62B0085001E	2440-2485	+2.1 typ. RHCP
2450AD14A5500001T	2400-2480 5150-5850	1.0 4.0
2450AD14A5500002T	2400-2480 5150-5850	1.0 4.0
2450AD18A6050001E	2400-2500 4900-5850 5850-7200	(+2.0 (YZ-plane))
2450AD18A6050002E	2400-2500 4900-5850 5850-7200	+1.9 +1.1 +3.0
2450AD18A7250001E	2400-2480 6000-8500	+3.0 +5.5
2450AD18A7250002E	2400-2480 6000-8500	+3.0 +5.5
2450AD46A5400001E	2400-2500 4900-5900	1.0 -1.5
2450AD47A1590001E	2400-2500 1561 1575 1602	1.0 0.5 1.5 1.5
2450AD47A1590002E	2400-2500 1561 1575 1602	1.0 0.5 1.5 1.5



RF Antennas (Dual, & Triple Bands)

World Leader in
Chip Antenna Design 

Part Number	Frequency (MHz)	Peak Gain (dBi)
2450AT07A0100001T	2400-2500	1.0
2450AT07A0100001T	2400-2500	1.0
2450AT07A0100002T	2400-2500	1.0
2450AT14A0100001T	2400-2480	-0.5
2450AT18A0100001E	2400-2500	-0.5
2450AT18B0100001E	2400-2500	0.5
2450AT18D0100001E	2400-2500	1.5
2450AT18A0100002E	2400-2500	0.5
2450AT18D0100002E	2400-2500	1.5
2450AT18E0100001E	2400-2500	1.0
2450AT42A0100001E	2400-2500	0.0
2450AT42B0100001E	2400-2500	0.0
2450AT42D0100001E	2400-2500	0.5
2450AT42E0100001E	2400-2500	-2.0
2450AT42E0100002E	2400-2500	-2.0
2450AT42E010B001E	2400-2500	-1.0 -1.0
2450AT42E010B002E	2400-2500	1.0 -1.0
2450AT43A0100001E	2400-2500	Vertical -2.0 Horizontal -2.0
2450AT43A0100002E	2400-2500	Vertical -2.0 Horizontal -2.0

Part Number	Frequency (MHz)	Peak Gain (dBi)
2450AT43B0100001E	2400-2500	1.3
2450AT43B0100002E	2400-2500	1.3
2450AT43F0100001E	24500-2500	2.1
2450AT45A0100001E	2400-2500	2.2
2450AT45A0100002E	2400-2500	2.2
2500AT43A0100001E	2450-2550	0.6
2500AT44M0400001E	2300-2700	2.0 2.5 2.0
2600AT44A0600001E	2300-2900	2.0
2650AT43A0100001E	2600-2700	0.5
3100AT51A7200001E	3100-10300	1.5
3600AT43A0400001E	3.4-3.8	1.6
4000AT44A1800001E	3100-4900	2.7
5400AT18A1000001E	5150-5875	2.0 -2.5
5500AT07A0900001T	5150-5875 5350-5900	0.0 -3.0
5500AT18A0725001E	5150-5875	2.0
7000AT18A1600001E	6200-8240	2.0
7000AT18A1600002E	6200-8240	2.0



EMI X2Y Filters



Features:

- Voltages from 6.3VDC to 500VDC+
- Available in EIA sizes from 0402 to 1812 depending on voltage rating.
- Effective attenuation from 100KHz to 17GHz with various bandwidths.
- Designed to attenuate unwanted electromagnetic interference such as noise or spurious emissions at specific frequencies.
- Can be used in both single ended (one source signal) and differential (+/- signal) applications.
- AEC-Q200 automotive qualification (as required)

Common Applications:

- | | | |
|-------------------------------------|------------------------|---------------------|
| • Power Bypass | • DC Drives & Motors | • EMC I/O Filtering |
| • FPGA / ASIC / μ -P Decoupling | • Mil/Aero Electronics | • Electric Vehicles |
| • Amplifier Filter & Decoupling | • Medical Electronics | • IT & Networking |
| • DC-DC Converter Designs | • Wireless Charging | • Industrial |
| • High Speed Data Filtering | • GSM/Antennas | |

Expert Design Support:

At Johanson, we understand the complexity and difficulty associated in dealing with unwanted issues in your circuit.

Our engineers are ready to support with:

- Identifying the right component(s) to solve your unwanted EMI X2Y Filters spikes.
- How to design-in and connect Johanson EMI X2Y Filters to your product's schematic to achieve the most effective results.
- Reviewing and optimize your PCB layout, and where required, advise on any necessary changes that can be made to improve EM compliance.

Designer's Tool: S21 Plotter:

Try out Johanson's S21 Plotter, an on-line tool for designers to quickly select different values or sizes and see the responses of each configuration: Visit JOHANSON Dielectrics website at: <https://s21plotter.johansondielectrics.com/>



EMI X2Y Filters

Capacitance Values

EMI Filtering (1 Y-Cap.)	<10pF	10pF	22pF	27pF	33pF	47pF	100pF	220pF	470pF	1000pF	1500pF	2200pF	4700pF	.010µF	.015µF	.022µF	.039µF	.047µF	0.10µF	0.18µF	0.22µF	0.33µF	0.40µF	0.47µF	1.0µF	
Power Bypass (2 Y-Caps.)	<20pF	20pF	44pF	54pF	66pF	94pF	200pF	440pF	940pF	2000pF	3000pF	4400pF	9400pF	.020µF	.030µF	.044µF	.078µF	.094µF	0.20µF	0.36µF	0.44µF	0.66µF	0.80µF	0.94µF	2.0µF	
Power Bypass CAP. CODE	XRX	100	220	270	330	470	101	221	471	102	152	222	472	103	153	223	393	473	104	184	224	334	404	474	105	
0402	NP0	50	50	50	50	50	50																			
	X7R							50	50	50	50	50	50	16												
0603	NP0	100	100	100	100	100	50	50																		
	X7R						100	100	100	100	100	100	100	50	25	25		16	10		10					
0805	NP0		100	100	100	100	100	100	50																	
	X7R						100	100	100	100	100	100	100	100	50	50		50	25							
1206	NP0									100																
	X7R													100	100	100		100	100*		16	16		10		
1210	X7R													500					100		100	100		25	16	
1410	X7R														500								100			
1812	X7R																500							100		

 Automotive version currently available for those values only

HOW TO ORDER

EM	CF	500	G	100	M	1	GV	001	B
Subfamily	Size	Voltage	DTC	Capacitance	Tol	Mark	Termination	Special Code	Pack
EM = EMI X2Y Filters	CF = 0402 CP = 0603 CT = 0805 DD = 1206 DF = 1210 DK = 1410 DR = 1812	6R3 = 6.3 V 100 = 10 V 160 = 16 V 250 = 25 V 500 = 50 V 101 = 100 V 501 = 500 V	G = NP0/C0G W = X7R	1st two digits are significant; third digit denotes number of zeros. 101 = 100 pF 102 = 1000 pF	A = ±0.05pF M = ±20%	1 = No Mark	GV = Ni/Sn (RoHs) GF = Polyterm Sn (RoHs) NT = Sn/Pb	001 = Default catalog item 002 = AEC-Q200	B = Bulk E = 7" Reel Emb Tape

Example: **EMCF500G100M1GV001B** EMI X2Y Filters , 0402, 50 V, NP0/C0G, 10.000pF, ±20%, no mark, Ni/Sn (RoHs), default catalog item, bulk



EMI X2Y Filters

Mechanical Characteristics

	EIA 0402 EMCF Series		EIA 0603 EMCP Series		EIA 0805 EMCT Series		EIA 1206 EMDD Series		EIA 1210 EMFD Series		EIA 1410 EMDK Series		EIA 1812 EMDR Series	
	In	mm	In	mm	In	mm	In	mm	In	mm	In	mm	In	mm
L	0.045 ± 0.003	1.143 ± 0.076	0.064 ± 0.005	1.626 ± 0.127	0.080 ± 0.008	2.032 ± 0.203	0.124 ± 0.010	3.150 ± 0.254	0.125 ± 0.010	3.175 ± 0.254	0.140 ± 0.010	0.140 ± 0.010	0.174 ± 0.010	4.420 ± 0.254
W	0.025 ± 0.003	0.635 ± 0.076	0.064 ± 0.005	0.889 ± 0.127	0.050 ± 0.008	1.270 ± 0.203	0.063 ± 0.010	1.600 ± 0.254	0.098 ± 0.010	2.489 ± 0.254	0.098 ± 0.010	2.490 ± 0.254	0.125 ± 0.010	3.175 ± 0.254
T	0.02 max.	0.508 max.	0.26 max.	0.660 max.	0.040 max.	1.016 max.	0.050 max.	1.270 max.	0.070 max.	1.778 max.	0.070 max.	1.778 max.	0.090 max.	2.286 max.
EB	0.008 ± 0.003	0.203 ± 0.076	0.010 ± 0.006	0.254 ± 0.152	0.012 ± 0.008	0.305 ± 0.203	0.016 ± 0.010	0.406 ± 0.254	0.018 ± 0.010	0.457 ± 0.254	0.018 ± 0.010	0.457 ± 0.254	0.022 ± 0.012	0.559 ± 0.305
CB	0.012 ± 0.003	0.305 ± 0.076	0.018 ± 0.004	0.457 ± 0.102	0.022 ± 0.005	0.559 ± 0.127	0.040 ± 0.005	1.016 ± 0.127	0.045 ± 0.005	1.143 ± 0.127	0.045 ± 0.005	1.143 ± 0.127	0.045 ± 0.005	1.143 ± 0.127

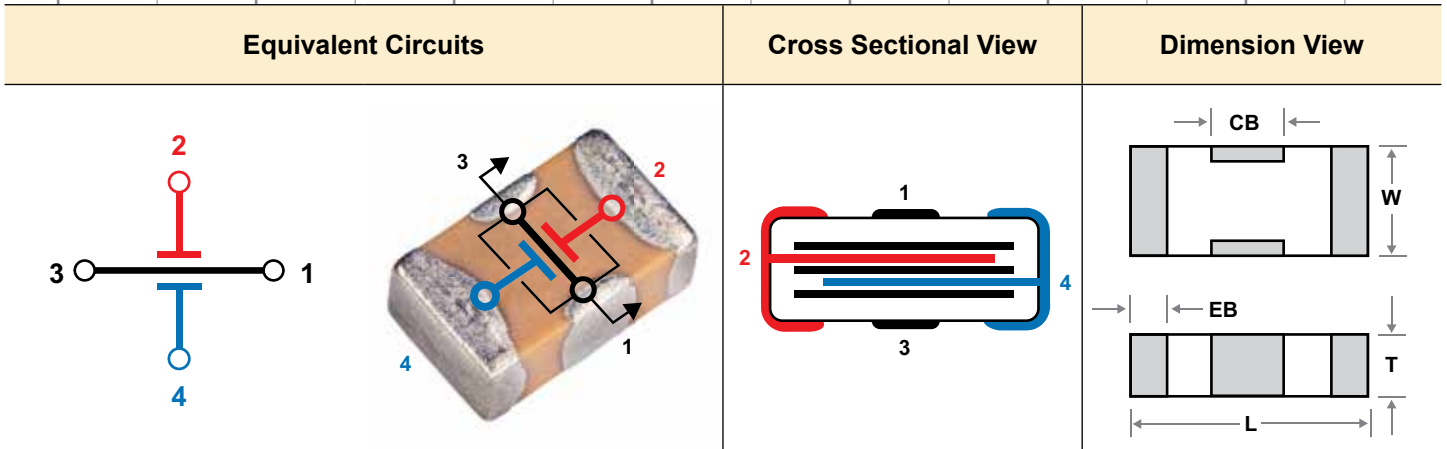

Electrical Characteristics

Type	NP0	X7R
Temperature Coefficient	0±30ppm/°C (-55 to +125°C)	±15% (-55 to +125°C)
Dielectric Strength	Vrated ≤ 100VDC: DWV = 2.5 X WVDC, 25°C, 50mA max. Vrated = 500VDC: DWV = 1.5 X WVDC, 25°C, 50mA max.	
Dissipation Factor	0.1% max.	WVDC ≥ 50 VDC: 2.5% max. WVDC = 25 VDC: 3.5% max. WVDC = 10-16 VDC: 5.0% max. WVDC = 6.3 VDC: 10% max
Insulation Resistance (Min @ 25°C WVDC)	C ≤ 0.047µF: 1000 ΩF or 100 GΩ, whichever is less C > 0.047µF: 500 ΩF or 10 GΩ, whichever is less	
Test Conditions	C > 100 pF; 1kHz ±50Hz; 1.0±0.2 VRMS C ≤ 100 pF; 1Mhz ±50kHz; 1.0±0.2 VRMS	1.0kHz±50Hz @ 1.0±0.2 Vrms



EMI X2Y Filters

Decoupling Characteristics

The EMI Design - A Balanced, Low ESL, "Capacitor Circuit"

The EMI capacitor design starts with standard 2 terminal MLC capacitor's opposing electrode sets, 2 & 4, and adds a third electrode set (1 and 3) which surround each 2 & 4 electrode. The result is a highly versatile three node capacitive circuit containing two tightly matched, low inductance capacitors in a compact, four-terminal SMT chip.

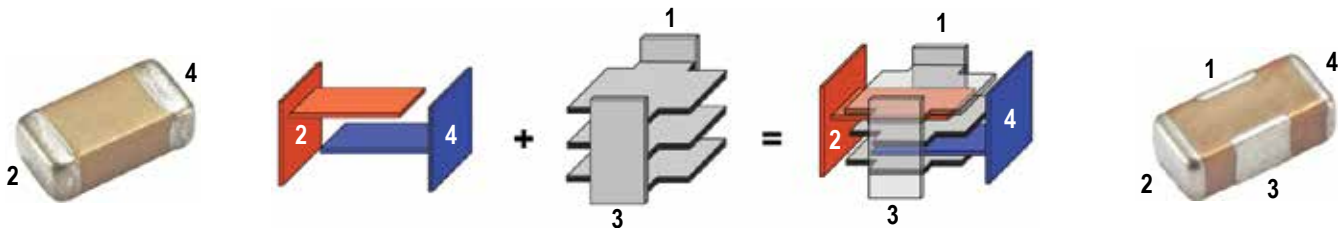

EMI Filtering

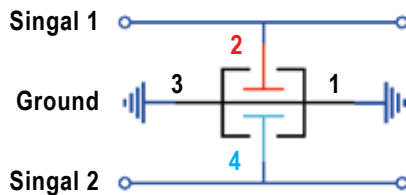

EMI Filtering:

The EMI component contains two shunt or "line-to-ground" Y capacitors. Ultra-low ESL (equivalent series inductance) and tightly matched inductance of these capacitors provides unequalled high frequency Common-Mode noise filtering with low noise mode conversion. EMI components reduce EMI emissions far better than unbalanced discrete shunt capacitors or series inductive filters. Differential signal loss is determined by the cut off frequency of the single line-to-ground (Y) capacitor value of an EMI.

Power Bypass S21

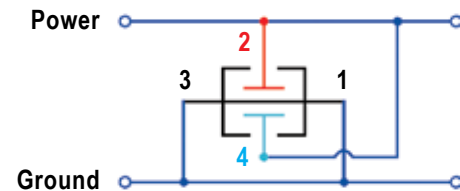

Power Bypass / Decoupling:

For Power Bypass applications, EMI's two "Y" capacitors are connected in parallel. This doubles the total capacitance and reduces their mounted inductance by 80% or 1/5th the mounted inductance of similar sized MLC capacitors enabling high-performance bypass networks with far fewer components and vias. Low ESL delivers improved High Frequency performance into the GHz range.

GSM RFI Attenuation in Audio & Analog

GSM handsets transmit in the 850 and 1850 MHz bands using a TDMA pulse rate of 217Hz. These signals cause the GSM buzz heard in a wide range of audio products from headphones to concert hall PA systems or "silent" signal errors created in medical, industrial process control, and security applications. Testing was conducted where an 840MHz GSM handset signal was delivered to the inputs of three different amplifier test circuit configurations shown below whose outputs were measured on a HF spectrum analyzer.

Legend:

- No input filter, 2 discrete MLC 100nF power bypass caps.
- 2 discrete MLC 1nF input filter, 2 discrete MLC 100nF power bypass caps.
- A single EMI 1nF input filter, a single EMI 100nF power bypass cap.

EMI configuration provided a nearly flat response above the ambient and up to 10 dB improved rejection than the conventional MLCC configuration.

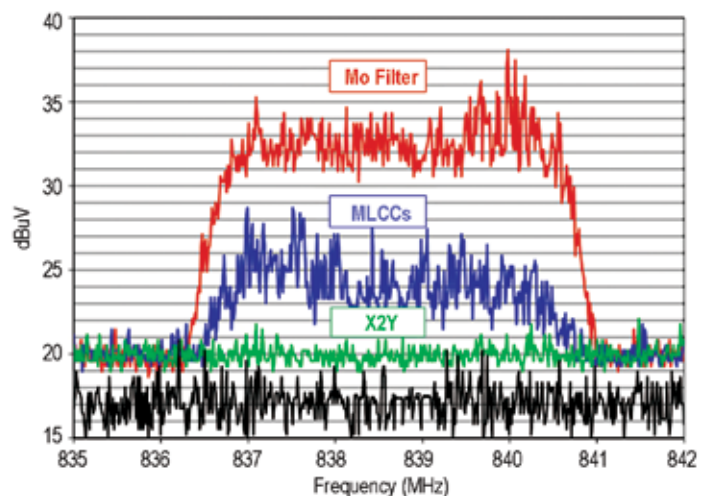



EMI X2Y Filters

EMI Filter & Decoupling Characteristics

EMI Filtering Scc21

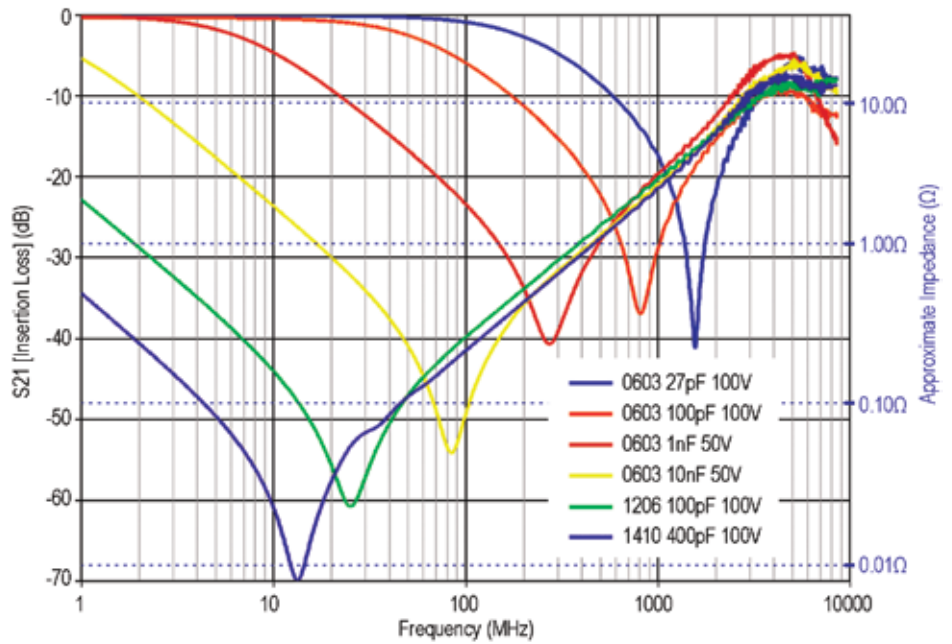
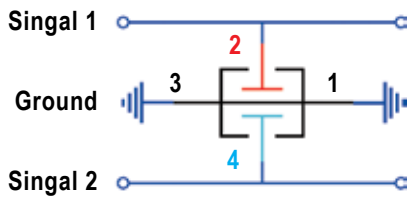

Power Bypass S21

Labeled capacitance values follow the P/N order code (single Y cap value)

Effective capacitance measured in Circuit 2 is 2X of the labeled single Y cap value.

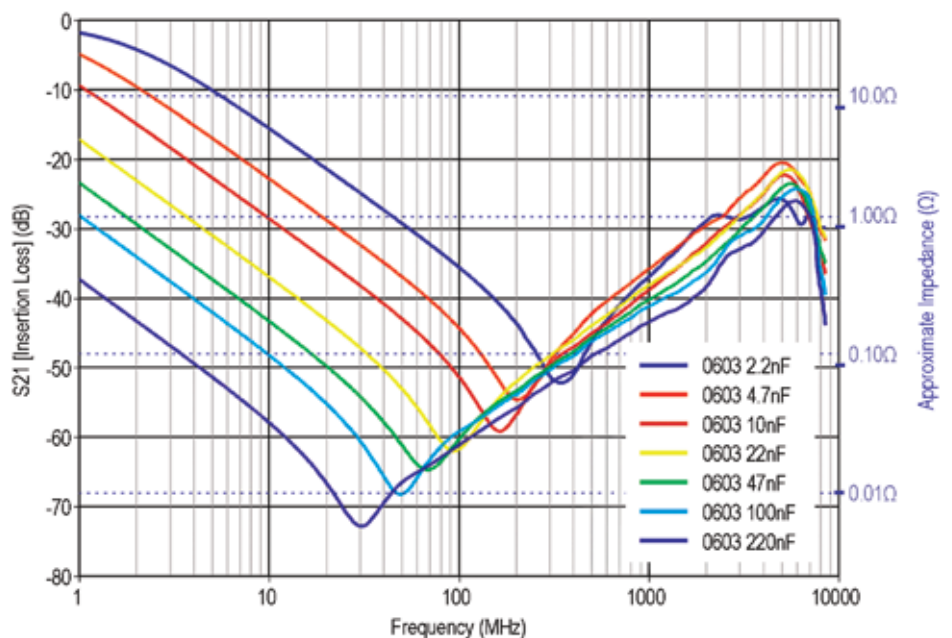
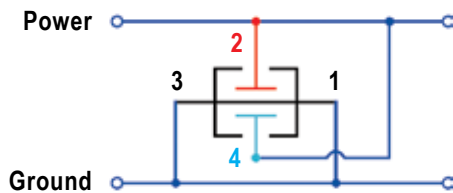



Capacitors
AC Power, SMT

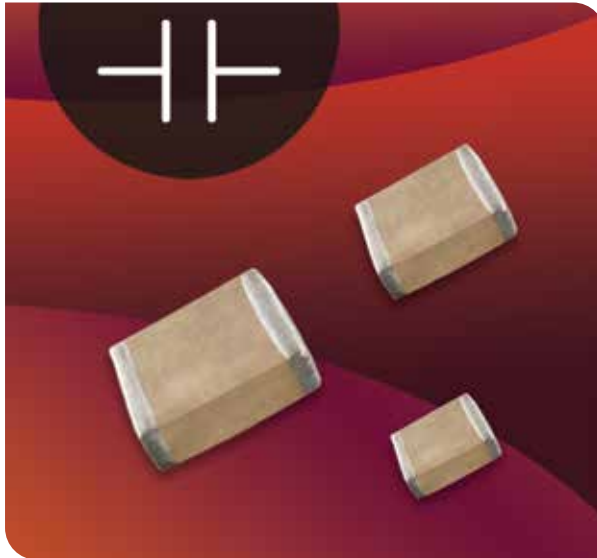

Features:

- Optimized for Power Handling
- Superior Lead-Free Solder Reflow Performance
- MSL = 1.0 Polyterm® Terminations Available
- RoHS Compliant

Common Applications:

- Superior Film Cap Replacement
- Florescent and HID Lighting Ballasts
- Industrial Controls
- Networking

EIA	Inches		(mm)	DC	AC	NP0 Dielectric		X7R Dielectric	
						Minimum	Maximum	Minimum	Maximum
1206	L	.125 ± .010	(3.17 ± .25)	250 VDC	141 Vrms	-	-	1000 pF	.068 pF
	W	.062 ± .010	(1.57 ± .25)	500 VDC	283 Vrms	10 pF	1500 pF	1000 pF	.027µF
	T	.067 Max.	(1.70)	630 VDC	356 Vrms	10 pF	1200 pF	1000 pF	.010 µF
	E/B	.020 ± .010	(0.51 ± .25)	1000 VDC	566 Vrms	10 pF	1000 pF	100 pF	5600 pF
1210	L	.125 ± .010	(3.18 ± .25)	250 VDC	141 Vrms	-	-	1000 pF	0.120 µF
	W	.095 ± .010	(2.41 ± .25)	500 VDC	283 Vrms	10 pF	3900 pF	1000 pF	.047 µF
	T	.080 Max.	(2.03)	630 VDC	356 Vrms	10 pF	2700 pF	1000 pF	.027 µF
	E/B	.020 ± .010	(0.51 ± .25)	1000 VDC	566 Vrms	10 pF	1800 pF	100 pF	.010 µF
1812	L	.180 ± .010	(4.57 ± .25)	250 VDC	141 Vrms	-	-	0.010 uF	0.220 µF
	W	.125 ± .010	(3.17 ± .25)	500 VDC	283 Vrms	100 pF	100 pF	1000 pF	0.150 µF
	T	.110 Max.	(2.80)	630 VDC	356 Vrms	100 pF	100 pF	1000 pF	0.100 µF
	E/B	.025 ± .015	(0.64 ± .38)	1000 VDC	566 Vrms	10 pF	10 pF	1000 pF	0.022 µF

HOW TO ORDER

AC	DD	102	W	102	K	1	GV	001	U
Subfamily	Size	Voltage	DTC	Capacitance	Tolerance	Mark	Term	Special Code	Pack
AC = Power Capacitor	See Chart Above	251 = 250V 501 = 500V 631 = 630V 102 = 1000V	G = NP0/ COG W = X7R	1st two digits are significant; 3rd digit denotes number of zeros. 102 = 1000 pF 104 = 0.10 µF	NP0: J = 5% K = 10% X7R: K = 10% M = 20%	1 = No Mark Z = Special Code	GV = Ni/Sn (RoHS) NT = Ni/Sn ZZ = Special Code	001 = Default catalog Item 002 = 1st special code 999 = Last special code	E = 7" Reel Emb Tape U = 13" Reel Emb Tape T = 7" Reel Paper Tape R = 13" Reel Paper Tape

Example: **ACDD102W102K1GV001U** AC Power Capacitors, 1206, X7R cap, 1,000.0V, 1,000.00pF±10% cap, Ni/Sn (RoHS) cap, 13" Reel Embossed Tape cap



Capacitors

AC Safety, SMT - (UL / TUV Certified)

X1, X2 and Y2 Capacitor Type Safety ceramic chip are designed for AC voltage surge and lightning protection in line-to-ground interface applications in computer networks, modem, facsimile and other equipment. Johanson Dielectric's safety capacitor offering includes four different case sizes and NPO and X7R dielectric materials. These devices are surface mount ready with barrier terminations and tape and reel packaging. Information on capacitor safety ratings and certification details may be found below.

General Specifications:

- Case Sizes: 1808 - 2220
- Safety Ratings: X2, X1/Y2, Y2
- Dielectrics Type: NPO, X7R
- Capacitance Range: 2.4 pF - 4700 pF

Polyterm® soft termination option for demanding environments & processes available on select parts, please contact the factory.

Dimensions

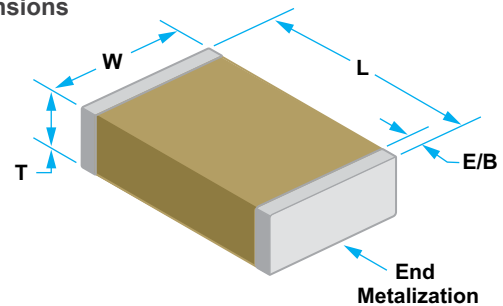

Safety Ratings

Safety Rating	Voltage Rating	Withstanding Voltage	Impulse Voltage	Case Size
X2	250 VAC	1,500 VAC	2,500 V	1808
STANDARDS: IEC/EN 60384-14:2013+A1:2016 • CERTIFICATIONS: TUV T 72210484 • UL File E472557				
X2	250 VAC	1,500 VAC	2,500 V	1812
STANDARDS: IEC/EN 60384-14:2013+A1:2016 • CERTIFICATIONS: TUV T 72210484 • UL File E472557				
X1/Y2	250 VAC	1,500 VAC	5,000 V	1808
STANDARDS: IEC/EN 60384-14:2013+A1:2016 • CERTIFICATIONS: TUV T 72210484 • UL File E472557				
X1/Y2	250 VAC	1,500 VAC	5,000 V	1812
STANDARDS: IEC/EN 60384-14:2013+A1:2016 • CERTIFICATIONS: TUV T 72210484 • UL File E472557				
X1/Y2	250 VAC	1,500 VAC	5,000 V	2211
STANDARDS: IEC/EN 60384-14:2013+A1:2016 • CERTIFICATIONS: TUV T 72210484 • UL File E472557				
X1/Y2	250 VAC	1,500 VAC	5,000 V	2220
STANDARDS: IEC/EN 60384-14:2013+A1:2016 • CERTIFICATIONS: TUV T 72210484 • UL File E472557				

X Capacitors are defined as suitable for use in situations where failure of the capacitor would not lead to danger of electric shock.
Y Capacitors are defined as suitable for use in situations where failure of the capacitor could lead to danger of electric shock.

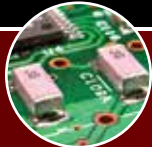

Capacitors
AC Safety, SMT - (UL / TUV Certified)

Electrical Characteristics

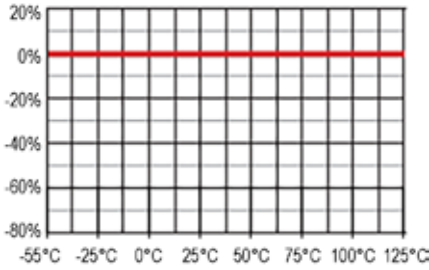
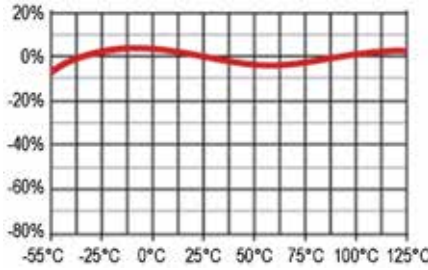
Parameter	NPO		X7R	
		0 ± 30 ppm/°C	-55 to + 125°C	± 15%
Temperature Coefficient				
	Dissipation Factor	3.0% max		WVDC > 50 VDC, DF = 2.5% max WVDC = 25 VDC, DF = 3.0% max WVDC = 16 VDC, DF = 3.5% max
Aging	None		2.5% / decade hour	
Insulation Resistance	1000ΩF or 100GΩ Whichever is less @ 25°C, WVDC		500ΩF or 50GΩ Whichever is less @ 25°C, WVDC	
Dielectric Strength	For Vrated = 6 - 200 VDC, DWV = 2.5 X WVDC, 25°C, 50mA max. For Vrated = 201 - 499 VDC, DWV = 2.0 X WVDC, 25°C, 50mA max. For Vrated = 500 - 999 VDC, DWV = 1.5 X WVDC, 25°C, 50mA max. For Vrated = 1000 + VDC, DWV = 1.2 X WVDC, 25°C, 50mA max.			
Test Parameters	C ≤ 100 pF 1MHz ± 50KHz; 1.0 ± 0.2 VRMS C > 100 pF 1KHz ± 50Hz; 1.0 ± 0.2 VRMS		1KHz ± 50Hz; 1.0 ± 0.2 VRMS	
Notes	TANCERAM IR = 100 ΩF or 10 GΩ, TANCERAM DF for Vrated > 50 VDC = 5% max., & TANCERAM DF for Vrated < 25 VDC, DF = 10% max.			

HOW TO ORDER

SC	DP	502	W	102	J	4	GF	001	E
Subfamily	Size	Voltage	DTC	Capacitance	Tol	Mark	Termination	Special Code	Pack
SC = AC Safety Caps	DP = 1808 ED = 2211 DR = 1812 EF = 2220	302 = 250VAC [2500V Impulse] 502 = 250VAC [5000V Impulse]	G = NPO/COG W = X7R	1st two digits are significant; 3rd digit denotes number of zeros. 101 = 100 pF 103 = 0.01 μF 105 = 1.00 μF	J = ± 5% K = ± 10% M = ± 20%	4 = Required safety mark	GV = Ni/Sn (RoHS) GF = Polyterm Sn (RoHS)	001 = Default catalog item	B = Bulk E = 7" Reel Emb Tape U = 13" Reel Emb Tape

Example: **SCDP502W102J4GF001E** Capacitors Safety Caps - SC, X1/Y2, 1808, X7R, 5000V, 1000pF, ±5%, Polyterm Sn (RoHS), 7" Reel Embossed Tape



Capacitors
AC Safety - (UL / TUV Certified)

Ratings & Voltage

LEGEND: Dielectric NPO X7R

1808																															
X2																															
Size	Inches	(MM)	5 pF	10 pF	12 pF	15 pF	18 pF	22 pF	27 pF	33 pF	47 pF	56 pF	68 pF	100 pF	120 pF	150 pF	180 pF	220 pF	270 pF	330 pF	470 pF	560 pF	680 pF	1000 pF	1200 pF	1500 pF	1800 pF	2200 pF	2700 pF	3300 pF	4700 pF
L	.185 ± .015	(4.70 ± .38)																													
W	.080 ± .010	(2.03 ± .25)																													
T	.085 Max.	(2.16)																													
E/B	.020 ± .010	(0.51 ± .25)																													
1812																															
X2																															
Size	Inches	(MM)	5 pF	10 pF	12 pF	15 pF	18 pF	22 pF	27 pF	33 pF	47 pF	56 pF	68 pF	100 pF	120 pF	150 pF	180 pF	220 pF	270 pF	330 pF	470 pF	560 pF	680 pF	1000 pF	1200 pF	1500 pF	1800 pF	2200 pF	2700 pF	3300 pF	4700 pF
L	.175 ± .010	(4.45 ± .25)																													
W	.125 ± .010	(3.18 ± .25)																													
T	.115 Max.	(2.92)																													
E/B	.025 ± .015	(0.64 ± .38)																													
1808																															
X1 / Y2																															
Size	Inches	(MM)	5 pF	10 pF	12 pF	15 pF	18 pF	22 pF	27 pF	33 pF	47 pF	56 pF	68 pF	100 pF	120 pF	150 pF	180 pF	220 pF	270 pF	330 pF	470 pF	560 pF	680 pF	1000 pF	1200 pF	1500 pF	1800 pF	2200 pF	2700 pF	3300 pF	4700 pF
L	.185 ± .015	(4.70 ± .38)																													
W	.080 ± .015	(2.03 ± .38)																													
T	.085 Max.	(2.16)																													
E/B	.020 ± .010	(0.51 ± .25)																													
1812																															
X1 / Y2																															
Size	Inches	(MM)	5 pF	10 pF	12 pF	15 pF	18 pF	22 pF	27 pF	33 pF	47 pF	56 pF	68 pF	100 pF	120 pF	150 pF	180 pF	220 pF	270 pF	330 pF	470 pF	560 pF	680 pF	1000 pF	1200 pF	1500 pF	1800 pF	2200 pF	2700 pF	3300 pF	4700 pF
L	.175 ± .010	(4.45 ± .25)																													
W	.125 ± .010	(3.18 ± .25)																													
T	.115 Max.	(2.92)																													
E/B	.025 ± .015	(0.64 ± .38)																													
2211																															
X1 / Y2																															
Size	Inches	(MM)	5 pF	10 pF	12 pF	15 pF	18 pF	22 pF	27 pF	33 pF	47 pF	56 pF	68 pF	100 pF	120 pF	150 pF	180 pF	220 pF	270 pF	330 pF	470 pF	560 pF	680 pF	1000 pF	1200 pF	1500 pF	1800 pF	2200 pF	2700 pF	3300 pF	4700 pF
L	.225 ± .016	(5.72 ± .40)																													
W	.110 ± .010	(2.80 ± .25)																													
T	.115 Max.	(2.92)																													
E/B	.020 ± .010	(0.51 ± .25)																													
2220																															
X1 / Y2																															
Size	Inches	(MM)	5 pF	10 pF	12 pF	15 pF	18 pF	22 pF	27 pF	33 pF	47 pF	56 pF	68 pF	100 pF	120 pF	150 pF	180 pF	220 pF	270 pF	330 pF	470 pF	560 pF	680 pF	1000 pF	1200 pF	1500 pF	1800 pF	2200 pF	2700 pF	3300 pF	4700 pF
L	.225 ± .015	(5.72 ± .38)																													
W	.200 ± .015	(5.08 ± .38)																													
T	.150 Max.	(3.81)																													
E/B	.025 ± .015	(0.64 ± .38)																													



Capacitors

Automotive Grade - Mid-Voltage High Capacitance



Features:

- Capacitance Range: 2.2nF to 15uF
- Voltages: 50 to 1000V
- Lead-free Termination
- AEC-Q200 Qualified
- RoHS Compliant

Application:

- Audio
- Infotainment Systems
- Climate Control Systems
- Key Fobs
- Touchscreen
- Cameras
- GPS
- Inverters
- Control Modules
- Engine Control Modules
- LED Lighting Systems
- Battery Management Systems (BMS)
- Automotive-48V DC/DC Converters
- EV on Board Charger (OBC)

Basic Construction

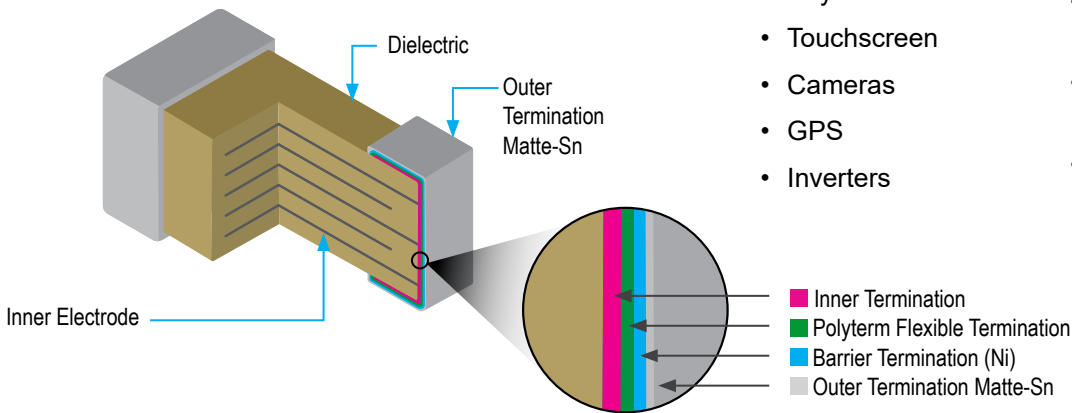

HOW TO ORDER

AM	DD	500	W	475	M	1	GF	002	E
Subfamily	Size	Voltage	DTC	Capacitance	Tolerance	Mark	Term	Special Code	Pack
AM = Automotive Grade Mid-Voltage High Capacitance	DD = 1206 DF = 1210 DP = 1808 EF = 2220	500 = 50V 101 = 100V 251 = 250V 631 = 630V 102 = 1000V	W = X7R G = NP0	1st two digits are significant; 3rd digit denotes number of zeros. 475 = 4.700 μ F 102 = 1000 pF;	J = \pm 5% K = \pm 10% M = \pm 20%	1 = No Mark	GF = Polyterm Sn (RoHS)	002 = AEC-Q200	B = Bulk E = 7" Reel Emb Tape U = 13" Reel Emb Tape

Example: **AMDD500W475M1GF002E** Automotive Grade Mid-Voltage High Capacitance, 1206, 50V, X7R, 4.700 μ F, \pm 20%, No Mark, Polyterm Sn (RoHS), AEC-Q200, and 7" Reel Embossed Tape



Capacitors

Automotive Grade - Mid-Voltage High Capacitance

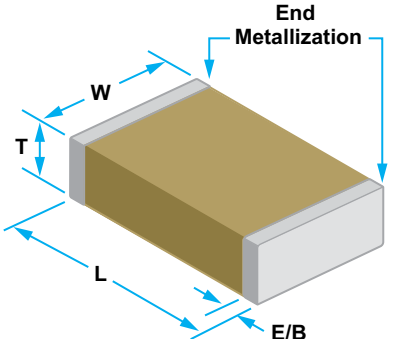

Mechanical Characteristics

EIA (Metric)	1206 (3216)		1210 (3225)		1808 (4520)		2220 (5750)		Mechanical Characteristics
	Inches	mm	Inches	mm	Inches	mm	Inches	mm	
Length "L"	0.130 ± 0.012	3.3 ± 0.30	0.130 ± 0.016	3.3 ± 0.40	0.177 ± 0.016	4.5 ± 0.40	0.224 ± 0.020	5.7 ± 0.50	
Width "W"	0.063 ± 0.012	1.6 ± 0.30	0.098 ± 0.012	2.5 ± 0.30	0.079 ± 0.010	2.0 ± 0.25	0.197 ± 0.016	5.0 ± 0.40	
Thickness "T"	See "Thickness" detail next page								
Endband "EB"	0.024 ± 0.008	0.6 ± 0.20	0.030 to 0.014	0.75 ± 0.35	0.033 ± 0.014	0.85 ± 0.35	0.033 ± 0.014	0.85 ± 0.35	

Electrical Characteristics

Rated Voltage (VDC)	50, 100, 250, 630, 1000 Volts DC
Capacitance Range (EIA)	2.2 nF to 15 uF (See size, capacitance & voltage range chart below)
Capacitance Tolerance	J, K, M
Test Parameters	1 MHz ± 50 kHz @ 1.0 ± 0.2 VRMS, 25°C
Temperature Coefficient	NP0: 0% ± 30 ppm/°C from -55 to 125°C X7R: ± 15% from -55 to 125°C
Quality Factor	Q > 1,000 at 1 MHz ± 50 kHz, 25°C, 1.0 ± 0.2 VRMS
Insulation Resistance	> 10 GΩ
Operating Environment Range	-55 to 125°C
Breakdown Voltage	<1000 WVDC x 2.5 min., 25°C, 50 mA Max > 1000 WVDC x 1.2 min., 25°C, 50 mA Max



Capacitors

Automotive Grade - Mid-Voltage High Capacitance



Standard Cap Values (nF), Rated Voltage and Thickness

1206 (3216) - EIA (Metric)

Cap Values (nF)

2.2	10	22	33	47	68	100	150	220	330	470	680	1,000	1,500	2,200	3,300	4,700
-----	----	----	----	----	----	-----	-----	-----	-----	-----	-----	-------	-------	-------	-------	-------

Voltage

1000	630	250	250	250	250	250	250	250	100	100	100	100	50	50	50	50
------	-----	-----	-----	-----	-----	-----	-----	-----	-----	-----	-----	-----	----	----	----	----

Thickness Max

"0.053 (1.35)"	"0.071 (1.80)"	"0.071 (1.80)"	"0.071 (1.80)"	"0.071 (1.80)"	"0.071 (1.80)"	"0.071 (1.80)"	"0.071 (1.80)"	"0.071 (1.80)"	"0.071 (1.80)"	"0.075 (1.90)"	"0.075 (1.90)"	"0.075 (1.90)"	"0.075 (1.90)"	"0.075 (1.90)"	"0.075 (1.90)"	"0.075 (1.90)"
-------------------	-------------------	-------------------	-------------------	-------------------	-------------------	-------------------	-------------------	-------------------	-------------------	-------------------	-------------------	-------------------	-------------------	-------------------	-------------------	-------------------

Thickness Min

"0.045 (1.15)"	"0.055 (1.4)"	"0.055 (1.40)"	"0.055 (1.40)"	"0.055 (1.40)"	"0.055 (1.40)"	"0.055 (1.40)"	"0.055 (1.40)"	"0.055 (1.40)"	"0.055 (1.40)"	"0.059 (1.50)"	"0.059 (1.50)"	"0.059 (1.50)"	"0.059 (1.50)"	"0.059 (1.50)"	"0.059 (1.50)"	"0.059 (1.50)"
-------------------	------------------	-------------------	-------------------	-------------------	-------------------	-------------------	-------------------	-------------------	-------------------	-------------------	-------------------	-------------------	-------------------	-------------------	-------------------	-------------------

1210 (3225) - EIA (Metric)

Cap Values (nF)

10	22	33	47	68	100	150	220	330	470	680	1,000	1,500	2,200	3,300	4,700	6,800	10,000
----	----	----	----	----	-----	-----	-----	-----	-----	-----	-------	-------	-------	-------	-------	-------	--------

Voltage

1000	631	631	200	200	200	200	200	200	200	200	100	100	100	100	100	50	50
------	-----	-----	-----	-----	-----	-----	-----	-----	-----	-----	-----	-----	-----	-----	-----	----	----

Thickness Max

"0.110 (2.80)"	"0.110 (2.80)"	"0.110 (2.80)"	"0.087 (2.20)"	"0.087 (2.20)"	"0.087 (2.20)"	"0.087 (2.20)"	"0.087 (2.20)"	"0.110 (2.80)"	"0.110 (2.80)"	"0.110 (2.80)"	"0.110 (2.80)"	"0.110 (2.80)"	"0.110 (2.80)"	"0.110 (2.80)"	"0.110 (2.80)"	"0.110 (2.80)"	"0.110 (2.80)"
-------------------	-------------------	-------------------	-------------------	-------------------	-------------------	-------------------	-------------------	-------------------	-------------------	-------------------	-------------------	-------------------	-------------------	-------------------	-------------------	-------------------	-------------------

Thickness Min

"0.087 (2.20)"	"0.087 (2.20)"	"0.087 (2.20)"	"0.055 (1.80)"	"0.055 (1.80)"	"0.055 (1.80)"	"0.055 (1.80)"	"0.055 (1.80)"	"0.087 (2.20)"	"0.087 (2.20)"	"0.087 (2.20)"	"0.087 (2.20)"	"0.087 (2.20)"	"0.087 (2.20)"	"0.087 (2.20)"	"0.087 (2.20)"	"0.087 (2.20)"	"0.087 (2.20)"
-------------------	-------------------	-------------------	-------------------	-------------------	-------------------	-------------------	-------------------	-------------------	-------------------	-------------------	-------------------	-------------------	-------------------	-------------------	-------------------	-------------------	-------------------

1808 (4520) - EIA (Metric)

Cap Values (nF)

2.2

Voltage

1000

Thickness Max

0.071 (1.80)

Thickness Min

0.055 (1.40)

2220 (5750) - EIA (Metric)

Cap Values (nF)

100	150	220	330	470	680	1,000	1,500	2,200	3,300	4,700	6,800	10,000	15,000
-----	-----	-----	-----	-----	-----	-------	-------	-------	-------	-------	-------	--------	--------

Voltage

500	500	500	500	500	250	630	100	100	100	100	100	100	100
-----	-----	-----	-----	-----	-----	-----	-----	-----	-----	-----	-----	-----	-----

Thickness Max

"0.122 (3.10)"	"0.122 (3.10)"	"0.122 (3.10)"	"0.122 (3.10)"	"0.122 (3.10)"	"0.122 (3.10)"	"0.122 (3.10)"	"0.122 (3.10)"	"0.122 (3.10)"	"0.110 (2.80)"	"0.110 (2.80)"	"0.110 (2.80)"	"0.110 (2.80)"	"0.110 (2.80)"	"0.110 (2.80)"	"0.110 (2.80)"
-------------------	-------------------	-------------------	-------------------	-------------------	-------------------	-------------------	-------------------	-------------------	-------------------	-------------------	-------------------	-------------------	-------------------	-------------------	-------------------

Thickness Min

"0.098 (2.50)"	"0.098 (2.50)"	"0.098 (2.50)"	"0.098 (2.50)"	"0.098 (2.50)"	"0.098 (2.50)"	"0.098 (2.50)"	"0.098 (2.50)"	"0.098 (2.50)"	"0.087 (2.20)"	"0.087 (2.20)"	"0.087 (2.20)"	"0.087 (2.20)"	"0.087 (2.20)"	"0.087 (2.20)"	"0.087 (2.20)"
-------------------	-------------------	-------------------	-------------------	-------------------	-------------------	-------------------	-------------------	-------------------	-------------------	-------------------	-------------------	-------------------	-------------------	-------------------	-------------------

Legend

- Blue shade represents NPO Dielectric
- Red shade represents X7R Dielectric

Capacitors

High Reliability, SMT - NPO (COG)

Johanson high reliability surface-mount (SMT) capacitors are designed to withstand harsh environmental conditions, such as; extreme high and low temperatures, humidity, and shock/vibration. While providing consistently good performance over a long operating life.

Features:

- Designed with high-quality and durable materials.
- A wide array of special testing to meet specific quality capacitor requirements.
- Typically, offered NP0/COG and X7R materials in SMT capacitors.
- Special high reliability testing per MIL-PRF-123, MIL-PRF-55681, MIL-PRF-35325 and MIL-PRF-49467 are provided and commonly referenced requirements.

NPO (COG) Size Voltage Min/Max Cap Configurations (pF)

Size	MinCap	Low Voltage								Thickness Maximum	
		16V	25V	50V	100V	200V	250V	in	mm		
0201	0.1	0.2	0.18	50						0.013	0.3
0402	0.2	680	560	330						0.024	0.61
0403	0.2		100	100						0.044	1.12
0504	0.2		680	680	680					0.044	1.12
0603	0.2			1000	430	220	100			0.035	0.89
0805	0.5			2200	910	560	220			0.054	1.37
1206	1			10000	2200	1000				0.064	1.63
1210	1			6200	2700	1600				0.065	1.63
1808	5					6200				0.080	2.03
1812	5			22000	10000	8200				0.100	2.54

Size	MinCap	High Voltage								Thickness Maximum	
		500V	630V	1kV	2kV	3kV	4kV	5kV	6kV	in	mm
0805	0.5	680								0.054	1.37
1206	1	1500	1200	1000	220	82				0.064	1.63
1210	1	3900	2700	1800	560	220				0.065	1.63
1808	5	4700	3300	2200	820	470	180	75	75	0.080	2.03
1812	5	8200	6800	5600	1800	1000	390	150	150	0.100	2.54
1825	5	18000	15000	12000	5600	2200	1200	390	390	0.140	3.56
2220	10	18000	18000	15000	5600	2700	1500	470	470	0.180	4.57
2225	10	27000	22000	18000	8200	3300	1800	470	470	0.150	3.81



Capacitors

High Reliability, SMT - X7R (nF)

X7R Size Voltage Min/Max Cap Configurations (nF)

Size	MinCap	Low Voltage						Thickness Maximum	
		16V	25V	50V	100V	200V	250V	in	mm
0402	0.12	36	18	10	4	1	0.47	0.024	0.61
0403	0.12	51	20	12	6.8	2	1.5	0.044	1.12
0504	0.12	75	47	27	16	6.8	4.7	0.044	1.12
0603	0.12	100	75	47	22	10	7.5	0.035	0.89
0805	0.12	330	220	150	100	47	22	0.054	1.37
1206	0.24	1000	680	390	220	100	62	0.064	1.63
1210	0.24	1200	820	510	330	180	120	0.065	1.63
1808	0.24	1500	1000	620	390	240	160	0.080	2.03
1812	0.24	2000	1200	820	620	470	360	0.100	2.54
1825	0.47	2400	1600	1200	910	680	510	0.140	3.56
2220	0.47	3300	2400	1800	1300	910	680	0.180	4.57
2225	0.47	4300	3300	2400	1800	1300	820	0.150	3.81
4040	1	9100	6800	5100	3900	2700	1800	0.300	7.62
6560	100	20000	15000	11000	8200	5600	3900	0.300	7.62

Size	MinCap	High Voltage									Thickness Maximum	
		500V	630V	1kV	2kV	3kV	4kV	5kV	6kV	10kV	in	mm
0402	0.12										0.024	0.61
0504	0.12										0.044	1.12
0603	0.12	3.9	3	1.5							0.035	0.89
0805	0.12	10	5.6	2.7	1						0.054	1.37
1206	0.24	33	22	10	4.7	1					0.064	1.63
1210	0.24	68	43	15	6.8	1.3					0.065	1.63
1808	0.24	100	62	22	10	3.3	1	0.33	0.15		0.080	2.03
1812	0.24	240	150	82	24	4.7	1.3	0.75	0.33		0.100	2.54
1825	0.47	360	210	120	33	8.2	2.2	1.2	0.68		0.140	3.56
2220	0.47	470	270	150	39	10	2.7	1.5	0.82		0.180	4.57
2225	0.47	560	360	180	56	14	4.3	2.7	1.2		0.150	3.81
4040	1	1200	820	390	120	24	8.2	5.6	3.9	2.4	0.300	7.62
6560	100	2400	1600	820	240	47	15	11	8.2	5.1	0.300	7.62



Capacitors

High Voltage, SMT, 250 - 6,000



Note: Capacitors may require a surface coating to prevent external arcing. Solder mask should not be used beneath capacitors. For more information, visit "Surface Arc Season":

<https://www.johansondielectrics.com/arc-season-and-board-design-observations>

Features:

- Diverse Case Sizes, Voltages, & Capacitance Ranges
- DC Voltages from 500 through 6KV
- Case Sizes 0805 - 2225
- Capacitance Range: 10 pF - 0.47 μF
- Dielectrics Type: NP0, X7R
- Soft Polyterm® available to reduce stress. (Contact factory).

Common Applications:

- Analog & Digital Modems
- Voltage Multipliers
- DC-DC Converters
- Lighting Ballast Circuit
- Back-lighting Inverters
- LAN/WAN Interface

Electrical Specifications:

Dielectric Withstanding Voltage:





- DWV = 1.5 X rated WVDC for ratings 500-999 WVDC
- DWV = 1.2 X rated WVDC for ratings ≥ 1,000 WVDC

Case Size				Capacitance Selection				
EIA	Sizes	Inches	(mm)	Rated Voltage	NP0 Dielectric		X7R Dielectric	
					Minimum	Maximum	Minimum	Maximum
0805	L	.080 ±.010	(2.03 ±.25)	250 VDC	-	-	1000 pF	0.022 μF
	W	.050 ±.010	(1.27 ±.25)	500 VDC	10 pF	680 pF	1000 pF	0.010 μF
	T	.055 Max.	(1.40)	630 VDC	10 pF	560 pF	1000 pF	6800 pF
	E/B	.020 ±.010	(0.51±.25)	1000 VDC	10 pF	390 pF	100 pF	2700 pF
1206	L	.125 ±.010	(3.18 ±.25)	250 VDC	-	-	1000 pF	0.068 μF
	W	.062 ±.010	(1.57 ±.25)	500 VDC	10 pF	1500 pF	1000 pF	0.033 μF
	T	.067 Max.	(1.70)	630 VDC	10 pF	1200 pF	1000 pF	0.027 μF
	E/B	.020 ±.010	(0.51±.25)	1000 VDC	10 pF	1000 pF	100 pF	0.010 μF
				2000 VDC	10 pF	820 pF	100 pF	4700 pF
3000 VDC	10 pF	82 pF	100 pF	1000 pF				
1210	L	.125 ±.010	(3.18 ±.25)	250 VDC	-	-	1000 pF	0.150 μF
	W	.095 ±.010	(2.41 ±.25)	500 VDC	10 pF	3900 pF	1000 pF	0.068 μF
	T	.080 Max.	(2.03)	630 VDC	10 pF	2700 pF	1000 pF	0.047 μF
	E/B	.020 ±.010	(0.51±.25)	1000 VDC	10 pF	1800 pF	100 pF	0.015 μF
				2000 VDC	10 pF	560 pF	100 pF	4700 pF
3000 VDC	10 pF	220 pF	100 pF	1000 pF				
1808	L	.080 ±.010	(2.03 ±.25)	500 VDC	10 pF	4700 pF	1000 pF	0.100 μF
				630 VDC	10 pF	3300 pF	1000 pF	0.047 μF
				1000 VDC	1.0 pF	2200 pF	100 pF	0.022 μF
				2000 VDC	1.0 pF	820 pF	100 pF	0.010 μF
				3000 VDC	1.0 pF	470 pF	100 pF	3300 pF
				4000 VDC	1.0 pF	180 pF	100 pF	1800 pF
				5000 VDC	1.0 pF	75 pF	47 pF	390 pF
6000 VDC	1.0 pF	75 pF	47 pF	150 pF				

Available capacitor values include these significant retma values and their multiples: 1.0 1.2 1.5 1.8 2.2 2.7 3.3 3.9 4.7 5.6 6.8 8.2 (1.0 = 1.0, 10, 100, 1000, etc.) Consult factory for non-retma values and sizes or voltages not shown.



Capacitors
High Voltage Multi-Layer

Case Size				Capacitance Selection				
EIA	Sizes	Inches	(mm)	Rated Voltage	NP0 Dielectric		X7R Dielectric	
					Minimum	Maximum	Minimum	Maximum
 1812	L	.177 ±.012	(4.50 ±.30)	250 VDC	-	-	0.010 µF	0.470 µF
	W	.125 ±.010	(3.18 ±.25)	500 VDC	100 pF	8200 pF	1000 pF	0.330 µF
	T	.110 Max.	(2.80)	630 VDC	100 pF	6800 pF	1000 pF	0.120 µF
	E/B	.025 ±.015	(0.64±.38)	1000 VDC	10 pF	5600 pF	1000 pF	0.100 µF
				2000 VDC	10 pF	1800 pF	100 pF	0.010 µF
				3000 VDC	10 pF	1000 pF	100 pF	4700 pF
				4000 VDC	10 pF	390 pF	100 pF	1200 pF
				5000 VDC	10 pF	150 pF	100 pF	820 pF
			6000 VDC	10 pF	150 pF	10 pF	330 pF	
 1825	L	.180 ±.010	(4.57 ±.25)	500 VDC	100 pF	0.018 µF	0.01 µF	0.390 µF
	W	.250 ±.010	(6.35 ±.25)	630 VDC	100 pF	0.015 µF	0.01 µF	0.270 µF
	T	.140 Max.	(3.56)	1000 VDC	10 pF	0.012 µF	1000 pF	0.180 µF
	E/B	.025 ±.015	(0.64±.38)	2000 VDC	10 pF	5600 pF	100 pF	0.039 µF
				3000 VDC	10 pF	2200 pF	100 pF	8200 pF
				4000 VDC	10 pF	1200 pF	100 pF	2200 pF
				5000 VDC	10 pF	390 pF	100 pF	1500 pF
				6000 VDC	10 pF	390 pF	100 pF	820 pF
 2220	L	.225 ±.015	(5.72 ±.38)	500 VDC	1000 pF	0.018 µF	0.01 µF	0.470 µF
	W	.200 ±.015	(5.08 ±.38)	630 VDC	1000 pF	0.018 µF	0.01 µF	0.270 µF
	T	.150 Max.	(3.81)	1000 VDC	100 pF	0.015 µF	1000 pF	0.120 µF
	E/B	.025 ±.015	(0.64±.38)	2000 VDC	100 pF	5600 pF	1000 pF	0.039 µF
				3000 VDC	10 pF	2700 pF	100 pF	0.010 µF
				4000 VDC	10 pF	1500 pF	100 pF	2700 pF
				5000 VDC	10 pF	470 pF	100 pF	1500 pF
				6000 VDC	10 pF	470 pF	100 pF	820 pF
 2225	L	.225 ±.010	(5.72 ±.25)	500 VDC	1000 pF	0.027 µF	0.01 µF	0.560 µF
	W	.255 ±.015	(6.48 ±.38)	630 VDC	1000 pF	0.022 µF	0.01 µF	0.390 µF
	T	.160 Max.	(4.06)	1000 VDC	100 pF	0.018 µF	1000 pF	0.180 µF
	E/B	.025 ±.015	(0.64±.38)	2000 VDC	100 pF	8200 pF	1000 pF	0.056 µF
				3000 VDC	10 pF	3300 pF	100 pF	0.012 µF
				4000 VDC	10 pF	1800 pF	100 pF	3300 pF
				5000 VDC	10 pF	470 pF	100 pF	2700 pF
				6000 VDC	10 pF	470 pF	100 pF	1200 pF

Available cap. values include these significant retma values and their multiples: 1.0 1.2 1.5 1.8 2.2 2.7 3.3 3.9 4.7 5.6 6.8 8.2 (1.0 = 1.0, 10, 100, 1000, etc.) Consult factory for non-retma values and sizes or voltages not shown.

HOW TO ORDER

VP	DD	202	W	102	K	1	GV	001	E
Subfamily	Size	Voltage	DTC	Capacitance	Tol	Mark	Termination	Special Code	Pack
VP = High Volt PME SMD ≥ 500V	CT = 0805 DD = 1206 DP = 1808 DF = 1210	501 = 500 V 631 = 630 V 102 = 1000 V 202 = 2000 V	G = NP0/C0G W = X7R	1st two digits are significant; 3rd digit denotes number of zeros. 102 = 1000 pF 104 = 0.10 µF	J = ± 5% K = ±10% M = ±20%	1 = No mark 2 = EIA mark	GV = Ni/Sn (RoHS) NT = Ni/SnPb GF = Polyterm Sn (RoHS) ZZ = Special Code	001 = Default catalog item	B = Bulk E = Embossed 7" T = Punched 7"
VB = High Volt BME SMD ≥ 500V	DR = 1812 EF = 2220 EH = 2225 DV = 1825	302 = 3000 V 402 = 4000 V 502 = 5000 V 602 = 6000 V							

Example: **VPDD202W102K1GV001E** Capacitors HVS PME, 1206, X7R, 2000V, 1000pF±10%, Ni/Sn (RoHS), 7" Reel Embossed Tape



RF Capacitors

High-Q, Ultra-Low Loss, SMT



Johanson High-Q Capacitors are made in North America. These lines of SMT (surface-mount), Multi-Layer High-Q, were developed for High-Q and microwave applications. RoHS compliance is standard of all unleaded parts.

Features:

- Ultra Low Loss / Low ESR
- Designed and Manufactured to Control SRFs
- EIA Case Sizes 0201 to 3838
- AEC-Q200 Available

Common Applications:

- High Frequency Communications
- All Wireless Communications
- Battery-Powered Products
- RF Power Amplifiers
- RF Generators
- Matching Networks



Product Range Summary

Series	EIA Size	Capacitance Range	Additional Features
QL	0201 (QLCD Series)	0.1 to 50pF	<ul style="list-style-type: none"> • Made with Silver/Palladium Electrode • Mid High-Q Performance • Exhibit NP0 Temperature Characteristics • Temperature Range: -55°C to +125°C
QC	0402 (QCCF Series)	0.1pF to 33pF	<ul style="list-style-type: none"> • Made with Copper Electrodes • Ultra High-Q, and Low ESR (Enhanced ESR over 1.5GHz) • Performance with NP0 • Temperature Range: -55°C to +150°C
	0603 (QCCP Series)	0.1pF to 100pF	
	0805 (QCCT Series)	0.1pF to 220pF	
QS	0402 (QSCF Series)	0.1pF to 33pF	<ul style="list-style-type: none"> • Made with Silver/Palladium Electrodes • Ultra High-Q, and Low ESR • Performance with NP0 • Temperature Range: -55° C to +125 ° C
	0603 (QSCP Series)	0.1pF to 100pF	
	0805 (QSCT Series)	0.3pF to 220pF	
QE	1111 (QEDB Series)	0.2pF to 1000pF	<ul style="list-style-type: none"> • Made with Silver/Palladium Electrodes • Excellent high-Q, low ESR • High RF power, from HF to microwave • High Voltage High-Q • Temperature Range: -55°C to +125°C • Automotive version (AEC-Q200) available upon request for 1111
	2525 (QEEV Series)	1.0pF to 2700pF	
	3838 (QEFM Series)	1.0pF to 5100pF	
QG	0805 (QGCT Series)	0.3pF to 47pF: 1000V	<ul style="list-style-type: none"> • Non-Magnetic • For MRI & High Inductance Applications See web for details
		51pF to 100pF: 500V	

On request: Any of the High-Q Series, highest temperature can be extended to +150°C



RF Capacitors

Multi-Layer High-Q, Ultra-Low Loss

Mechanical Characteristics

Size	Units	Length	Width	Thickness	End Band
EIA 0201	In	.024 ± .001	.012 ± .001	.012 ± .001	.008 Max.
Metric 0603	mm	(0.60 ± 0.03)	(0.30 ± 0.03)	(0.30 ± 0.03)	(0.20 Max.)
EIA 0402	In	.040 ± .004	.020 ± .004	.020 ± .004	.010 ± .006
Metric 1005	mm	(1.02 ± 0.1)	(0.51 ± 0.1)	(0.51 ± 0.1)	(0.25 ± .15)
EIA 0603	In	.062 ± .006	.032 ± .006	.030 + .005 /- .003	.014 ± .006
Metric 1608	mm	(1.57 ± 0.15)	(0.81 ± 0.15)	(0.76 + .13 - .08)	(0.35 ± .15)
EIA 0805	In	.080 ± .008	.050 ± .008	.040 ± .006	.020 ± .010
Metric 2012	mm	(2.03 ± 0.20)	(1.27 ± 0.20)	(1.02 ± .15)	(0.50 ± .25)
EIA 1111	In	0.110	0.110	0.102 Max.	0.015
Metric 2727	mm	(2.79)	(2.79)	(2.59) Max.	(0.38)
EIA 2525	In	0.230	0.250	0.150 Max.	0.025
Metric 6363	mm	(5.84)	(6.35)	(3.81) Max.	(0.63)
EIA 3838	In	0.380	0.380	0.170 Max.	0.025
Metric 9797	mm	(9.65)	(9.65)	(4.32) Max.	(0.63)

Environmental Characteristics

	Specification	Test Parameters
Solderability	Solder coverage ≥ 90% of metalized areas No termination degradation.	Preheat chip to 120° - 150°C for 60 sec., dip terminals in rosin flux then dip in Sn62 solder @ 240° ± 5°C for 5 ± 1 sec.
Resistance to Soldering Heat	Solder coverage ≥ 90% of metalized areas No termination degradation.	Preheat device to 80° - 100°C for 60 sec. followed by 150° - 180°C for 60 sec. Dip in 260° ± 5°C solder for 10 ± 1 sec. Measure after 24 ± 2 hour cooling period.
Terminal Adhesion	Termination should not pull off. Ceramic should remain undamaged.	Linear pull force* exerted on axial leads soldered to each terminal. *0402 ≥ 2.0lbs, 0603 ≥ 4.0lbs (min.)
PCB Deflection	Termination should not pull off. Ceramic should remain undamaged.	PCB Deflection Spec
Vibration	No mechanical damage. Capacitance change: ± 2.5% or 0.25pF Q>1000 I.R. ≥ 10 G-Ohm. Breakdown voltage: 2.5 x WVDC	Cycle performed for 2 hours in each of three perpendicular directions. Frequency range 10Hz to 55 Hz to 10 Hz traversed in 1 minute. Harmonic motion amplitude: 1.5mm.
Humidity, Steady State	No mechanical damage. Capacitance change: ± 5.0% or 0.50pF max. Q>300 I.R. ≥ 1 G-Ohm. Breakdown voltage: 2.5 x WVDC	Relative humidity: 90 - 95%. Temperature: 40° ± 2°C Test time: 500 +12/-0 Hours Measure after 24 ± 2 hour cooling period
Humidity, Low Voltage	No mechanical damage. Capacitance change: ± 5.0% or 0.50pF max. Q>300 I.R. = 1 G-Ohm min. Breakdown voltage: 2.5 x WVDC	Applied voltage: 1.5 VDC, 50 mA max. Relative humidity: 85 ± 2%. Temperature: 40° ± 2°C. Test time: 240 +12 / -0 Hours Measure after 24 ± 2 hour cooling period
Thermal Cycle	No mechanical damage. Capacitance change: ± 2.5% or 0.25pF Q>2000 I.R. >10 G Ohms. Breakdown voltage: 2.5 x WVDC	5 cycles of: 30 ± 3 minutes @ -55° + 0 / -3°C, 2-3 min. @ 25°C, 30 ± 3 min. @ +125° + 3 / -0°C, 2-3 min. @ 25°C Measure after 24 ± 2 hour cooling period.
Life Test	MIL-STD-202, Method 108 No mechanical damage. Capacitance change: ± 3.0% or 0.3 pF Q>500 I.R. >1 G Ohms. Breakdown voltage: 2.5 x WVDC	Applied voltage: 200% of WDCV for capacitors rated at 500 volts DC or less. Temperature: 125° ± 3°C. Test time: 1000 + 48 - 0 hours



RF Capacitors

Multi-Layer High-Q, Ultra-Low Loss



Technical Notes:

S-Parameter Application Note: <https://www.johansontechnology.com/s-parameter-app-note>

Download Measured S-Parameters: <https://www.johansontechnology.com/s-parameter>

Recommended Land Pattern: <https://www.johansontechnology.com/pcb-pad-layout-recommendations>

Typical Soldering Profiles: <https://www.johansontechnology.com/typical-soldering-profile>

RoHS Compliance: <https://www.johansontechnology.com/rohs-compliance>

Dielectric

Characteristics	Test Parameters
Temperature Coefficient	0 ± 30ppm /°C, -55 to 150°C
Quality Factor / DF	Q >1,000 @ 1 MHz, Typical 10,000
Insulation Resistance	>10 GΩ @ 25°C, WVDC; 125°C IR is 10% of 25°C rating
Dielectric Strength	2.5 X WVDC Min., 25°C, 50 mA max
Test Parameters	1MHz ±50kHz, 1.0±0.2VRMS for capacitance values ≤ 1,000pF 1kHz ±50Hz, 1.0±0.2VRMS for capacitance values > 1,000pF
Available Capacitance	Size 0201: 0.2 - 100 pF Size 0402: 0.2 - 33 pF Size 0603: 0.2 - 100 pF Size 0805: 0.3 - 220 pF Size 1111: 0.2 - 1000 pF Size 2525: 0.5 - 2700 pF Size 3838: 0.5 - 5100 pF



RF Capacitors

Multi-Layer High-Q, Ultra-Low Loss

Voltage Ratings Chart

EIA Size		RF Power Applications													
		0201 (QLC)	0402 (QSCF)	0402 (QCCF)	0603 (QSCP)	0603 (QCCP)	0805 (QSCT)	0805 (QLCT)	0805 (QCCT)	1111 (QEDB)	2525 (QEEV)	3838 (QEFM)			
Cap. Value		NP0 (QLCD)													
Capacitance		Tolerance													
pF	Code														
0.1	0R1	25/50 V	50/250 V	250V	250 V	500V				1000V					
0.2	0R2	25/50 V	50/250 V	250V	250 V	500V				1000V	500V	1500V			
0.3	0R3	25/50 V	50/250 V	250V	250 V	500V	250 V			1000V	500V	1500V			
0.4	0R4	25/50 V	50/250 V	250V	250 V	500V	250 V			1000V	500V	1500V			
0.5	0R5	25/50 V	50/250 V	250V	250 V	500V	250 V			1000V	500V	1500V	3600V		
0.6	0R6	25/50 V	50/250 V	250V	250 V	500V	250 V			1000V	500V	1500V	3600V	3600V	7200V
0.7	0R7	25/50 V	50/250 V	250V	250 V	500V	250 V			1000V	500V	1500V	3600V	3600V	7200V
0.8	0R8	25/50 V	50/250 V	250V	250 V	500V	250 V			1000V	500V	1500V	3600V	3600V	7200V
0.9	0R9	25/50 V	50/250 V	250V	250 V	500V	250 V			1000V	500V	1500V	3600V	3600V	7200V
1.0	1R0	25/50 V	50/250 V	250V	250 V	500V	250 V			1000V	500V	1500V	3600V	3600V	7200V
1.1	1R1	25/50 V	50/250 V	250V	250 V	500V	250 V			1000V	500V	1500V	3600V	3600V	7200V
1.2	1R2	25/50 V	50/250 V	250V	250 V	500V	250 V			1000V	500V	1500V	3600V	3600V	7200V
1.3	1R3	25/50 V	50/250 V	250V	250 V	500V	250 V			1000V	500V	1500V	3600V	3600V	7200V
1.4	1R4	25/50 V	50/250 V	250V	250 V	500V	250 V			1000V	500V	1500V	3600V	3600V	7200V
1.5	1R5	25/50 V	50/250 V	250V	250 V	500V	250 V			1000V	500V	1500V	3600V	3600V	7200V
1.6	1R6	25/50 V	50/250 V	250V	250 V	500V	250 V			1000V	500V	1500V	3600V	3600V	7200V
1.7	1R7	25/50 V	50/250 V	250V	250 V	500V	250 V			1000V	500V	1500V	3600V	3600V	7200V
1.8	1R8	25/50 V	50/250 V	250V	250 V	500V	250 V			1000V	500V	1500V	3600V	3600V	7200V
1.9	1R9	25/50 V	50/250 V	250V	250 V	500V	250 V			1000V	500V	1500V	3600V	3600V	7200V
2.0	2R0	25/50 V	50/250 V	250V	250 V	500V	250 V			1000V	500V	1500V	3600V	3600V	7200V
2.1	2R1	25/50 V	50/250 V	250V	250 V	500V	250 V			1000V	500V	1500V	3600V	3600V	7200V
2.2	2R2	25/50 V	50/250 V	250V	250 V	500V	250 V			1000V	500V	1500V	3600V	3600V	7200V
2.4	2R4	25/50 V	50/250 V	250V	250 V	500V	250 V			1000V	500V	1500V	3600V	3600V	7200V
2.7	2R7	25/50 V	50/250 V	250V	250 V	500V	250 V			1000V	500V	1500V	3600V	3600V	7200V
3.0	3R0	25/50 V	50/250 V	250V	250 V	500V	250 V			1000V	500V	1500V	3600V	3600V	7200V
3.3	3R3	25/50 V	50/250 V	250V	250 V	500V	250 V			1000V	500V	1500V	3600V	3600V	7200V
3.6	3R6	25/50 V	50/200 V	250V	250 V	500V	250 V			1000V	500V	1500V	3600V	3600V	7200V
3.9	3R9	25/50 V	50/200 V	250V	250 V	500V	250 V			1000V	500V	1500V	3600V	3600V	7200V
4.3	4R3	25/50 V	50/200 V	250V	250 V	500V	250 V			1000V	500V	1500V	3600V	3600V	7200V
4.7	4R7	25/50 V	50/200 V	250V	250 V	500V	250 V			1000V	500V	1500V	3600V	3600V	7200V
5.1	5R1	25/50 V	50/200 V	250V	250 V	500V	250 V			1000V	500V	1500V	3600V	3600V	7200V
5.6	5R6	25/50 V	50/200 V	250V	250 V	500V	250 V			1000V	500V	1500V	3600V	3600V	7200V
6.2	6R2	25/50 V	50/200 V	250V	250 V	500V	250 V			1000V	500V	1500V	3600V	3600V	7200V
6.8	6R8	25/50 V	50/200 V	250V	250 V	500V	250 V			1000V	500V	1500V	3600V	3600V	7200V
7.5	7R5	25/50 V	50/200 V	250V	250 V	500V	250 V			1000V	500V	1500V	3600V	3600V	7200V
8.2	8R2	25/50 V	50/200 V	250V	250 V	500V	250 V			1000V	500V	1500V	3600V	3600V	7200V
9.1	9R1	25/50 V	50/200 V	250V	250 V	500V	250 V			1000V	500V	1500V	3600V	3600V	7200V
10	100	25/50 V	50/200 V	250V	250 V	500V	250 V			1000V	500V	1500V	3600V	3600V	7200V
11	110	25/50 V	50/200 V	250V	250 V	500V	250 V			1000V	500V	1500V	3600V	3600V	7200V
12	120	25/50 V	50/200 V	250V	250 V	500V	250 V			1000V	500V	1500V	3600V	3600V	7200V
13	130	25/50 V	50/200 V	250V	250 V	500V	250 V			1000V	500V	1500V	3600V	3600V	7200V
15	150	25/50 V	50/200 V	250V	250 V	500V	250 V			1000V	500V	1500V	3600V	3600V	7200V
16	160	25/50 V	50/200 V	250V	250 V	500V	250 V			1000V	500V	1500V	3600V	3600V	7200V
18	180	25/50 V	50/200 V	250V	250 V	500V	250 V			1000V	500V	1500V	3600V	3600V	7200V
20	200	25/50 V	50/200 V	250V	250 V	500V	250 V			1000V	500V	1500V	3600V	3600V	7200V
22	220	25/50 V	50/200 V	250V	250 V	500V	250 V			1000V	500V	1500V	3600V	3600V	7200V
24	240	25/50 V	50/200 V	250V	250 V	500V	250 V			1000V	500V	1500V	3600V	3600V	7200V
27	270	25/50 V	50/200 V	250V	250 V	500V	250 V			1000V	500V	1500V	3600V	3600V	7200V
30	300	25/50 V	50 V	250V	250 V	500V	250 V			1000V	500V	1500V	3600V	3600V	7200V
33	330	25/50 V	50 V	250V	250 V	500V	250 V			1000V	500V	1500V	3600V	3600V	7200V



RF Capacitors

Multi-Layer High-Q, Ultra-Low Loss

Voltage Ratings Chart

EIA Size		RF Power Applications												
		0201 (QLC)	0402 (QSCF)	0402 (QCCF)	0603 (QSCP)	0603 (QCCP)	0805 (QSCT)	0805 (QLCT)	0805 (QCCT)	1111 (QEDB)	2525 (QEEV)	3838 (QEFM)		
Cap. Value		NP0 (QLCD)												
Capacitance		Tolerance												
pF	Code													
36	360	25/50 V			250 V	500V	250 V		1000V	500V	1500V	3600V	3600V	7200V
39	390	25/50 V			250 V	500V	250 V		1000V	500V	1500V	3600V	3600V	7200V
43	430	25/50 V			250 V	500V	250 V		1000V	500V	1500V	3600V	3600V	7200V
47	470	25/50 V			250 V	500V	250 V		1000V	500V	1500V	3600V	3600V	7200V
51	510	25/50 V			250 V	500V	250 V		1000V	500V	1500V	3600V	3600V	7200V
56	560				250 V	500V	250 V		1000V	500V	1500V	3600V	3600V	7200V
62	620				250 V	500V	250 V		1000V	500V	1500V	3600V	3600V	7200V
68	680				250 V	500V	250 V		1000V	500V	1500V	3600V	3600V	7200V
75	750				250 V	500V	250 V		1000V	500V	1500V	3600V	3600V	7200V
82	820	F			250 V	500V	250 V		1000V	500V	1500V	3600V	3600V	7200V
91	910				250 V	500V	250 V		1000V	500V	1500V	3600V	3600V	7200V
100	101	G			250 V	500V	250 V		1000V	500V	1500V	3600V	3600V	7200V
110	111						250 V		500V	300V	1000V	2500V	3600V	7200V
120	121	J					250 V		500V	300V	1000V	2500V	3600V	7200V
130	131						250 V		500V	300V	1000V	2500V	3600V	7200V
150	151						250 V		500V	300V	1000V	2500V	3600V	7200V
160	161	K					250 V		500V	300V	1000V	2500V	3600V	7200V
180	181						250 V		500V	300V	1000V	2500V	3600V	7200V
200	201						250 V		500V	300V	1000V	2500V	3600V	
220	221						250 V		500V	200V	1000V	2500V	3600V	
240	241							200/500V		200V	600V	2500V	3600V	
270	271							200/500V		200V	600V	2500V	3600V	
300	301							200/500V		200V	600V	1500V	3600V	
330	331							200/500V		200V	600V	1500V	3600V	
360	361							200/500V		200V	600V	1500V	3600V	
390	391							200/500V		200V	500V	1500V	3600V	
430	431							200/500V		200V	500V	1500V	2500V	
470	471							50V		200V	500V	1500V	2500V	
510	511							100V		200V	500V	1000V	2500V	
560	561							100V		200V	500V	1000V	2500V	
620	621							100V		200V	500V	1000V	2500V	
680	681							50V		200V		1000V	2500V	
750	751	F						50V		200V		1000V	2500V	
820	821							50V		200V		1000V	2500V	
910	911	G						50V		200V		1000V	1000V	
1000	102							50V		200V		1000V	1000V	
1200	122	J						50V				1000V	1000V	
1500	152							50V				500V	1000V	
1800	182							50V				500V	1000V	
2200	222	K						50V				300V	1000V	
2700	272											300V	500V	
3300	332												500V	
3900	392												500V	
4700	472												500V	
5100	512												500V	
10000	103												500V	



RF Capacitors

Multi-Layer High-Q, Ultra-Low Loss

HOW TO ORDER

QC	CT	102	Q	910	G	1	GV	001	K
Subfamily	Size	Voltage	DTC	Capacitance	Tol	Mark	Termination	Special Code	Pack
QS = S Series QE = E Series QL = L Series QC = C Series QG = G Series	CD = 0201 CF = 0402 CP = 0603 CT = 0805 DB = 1111 EV = 2525 FM = 3838	250 = 25V 500 = 50V 201 = 200V 251 = 250V 501 = 500V 102 = 1000V 152 = 1500V 252 = 2500V 362 = 3600V 722 = 7200V	Q = Hi-Q NP0/COG G = NP0/COG	1st two digits are significant; 3rd digit denotes number of zeros. 102 = 1000 pF 104 = 0.10 μF	<10pF A = ±0.05pF B = ±0.1pF C = ±0.25pF D = ±0.5pF ≥10pF F = ±1% G = ±2% J = ±5% K = ±10% X = +80%/-20%	1 = No mark 2 = EIA mark 3 = Cap Code & Tol Marking Available on 0805 and larger sizes AR = Axial Wire (RoHS) AN = Axial Wire (Ni/SnPb) R1 = Radial Ribbon RR = Radial Wire (Ni/Sn RoHS) RN = Radial Wire (Ni/SnPb) ZZ = Special Code	Nickel Barrier GV = Ni/Sn (RoHS) NT = Ni/SnPb GG = Ni/Au (RoHS) Non-Mag¹ GU = Cu/Sn (RoHS) NC = Cu/SnPb Mag¹ M1 = Microstrip A2 = Axial Ribbon	001 = Default catalog item 002³ = Default for AEC-Q200 0805 - 3838 K = 5" Reel Emb E = 7" Reel Emb U = 13" Reel Emb M = 5" Reel Emb Horizontally Oriented Electrodes Q¹ = 5" Reel Emb Vertically Oriented Electrodes G¹ = 7" Reel Emb Horizontally Oriented Electrodes P¹ = 7" Reel Emb Vertically Oriented Electrodes Tape Specs conform to EIA RS481	B = Bulk W = Waffle Pack 0201 - 0603 Y = 5" Reel Paper T = 7" Reel Paper R¹ = 13" Reel Paper

Example: **QCCT102Q910G1GV001K** Capacitors High-Q MLC C-Series, 0805, Hi-Q NP0/COG, 1,000.00V, 91.00pF±2%, Ni/Sn (RoHS), 5" Reel Embossed Tape

¹ - Not available for all MLCC. Contact factory for info.
² - WVDC - Working Voltage DC
³ - Qualification required for automotive application. Not available for all series. Contact factory for info.

Got questions on the part numbers?

Contact the Johanson technical team at: <https://www.johansontechnology.com/ask-a-question>

RF Capacitors

Multi-Layer High-Q, Ultra-Low Loss - 0201 Size

RF Characteristics

0201 - Resonant Frequency

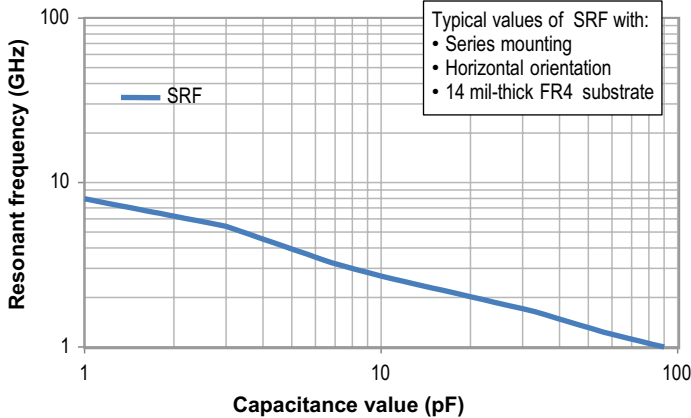

The Series Resonant Frequency is highly dependent on the substrate, pad dimensions, and measurement method. The above chart is for reference only.

0201 - Equivalent Series Resistance (ESR)

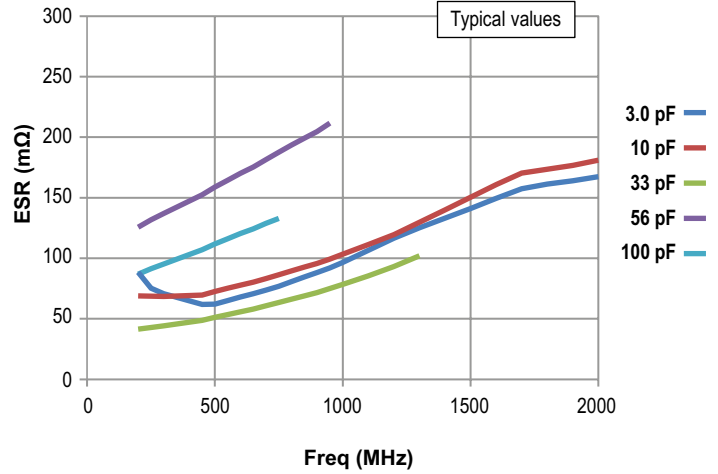

0201 - Q factor

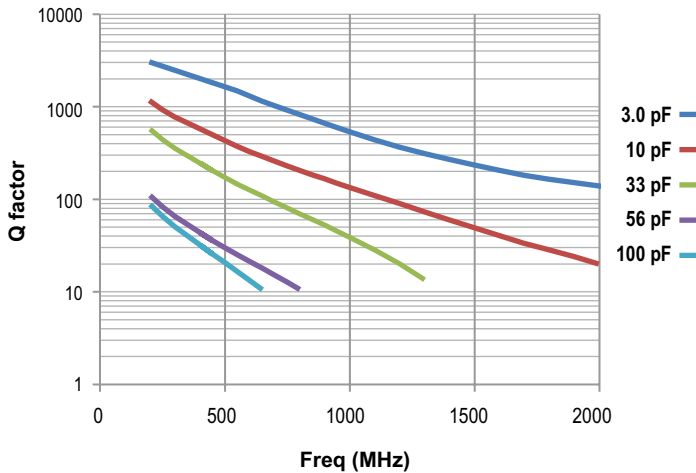

0201 - Max Current

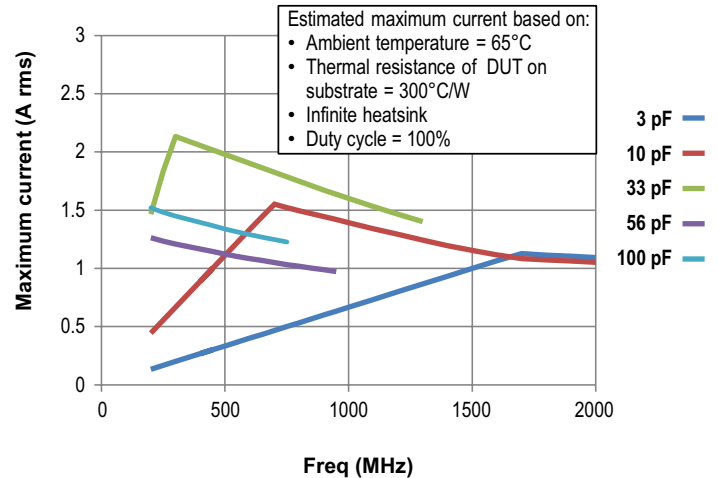

RF Capacitors

Multi-Layer High-Q, Ultra-Low Loss - 0402 Size

RF Characteristics

0402 - Series Resonant frequency

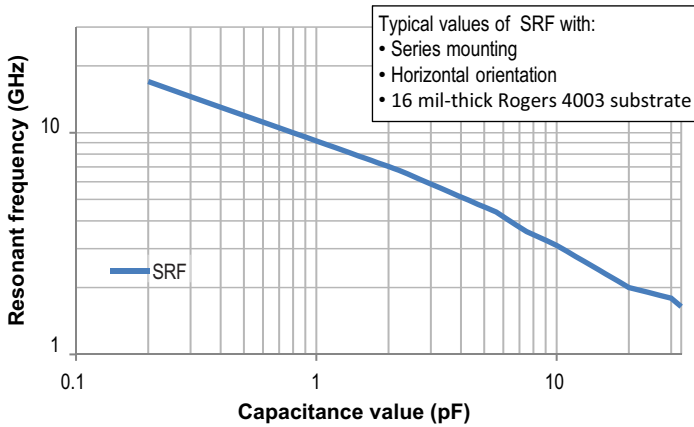

The Series Resonant Frequency is highly dependent on the substrate, pad dimensions, and measurement method. The above chart is for reference only.

0402 - Equivalent Series Resistance (ESR)

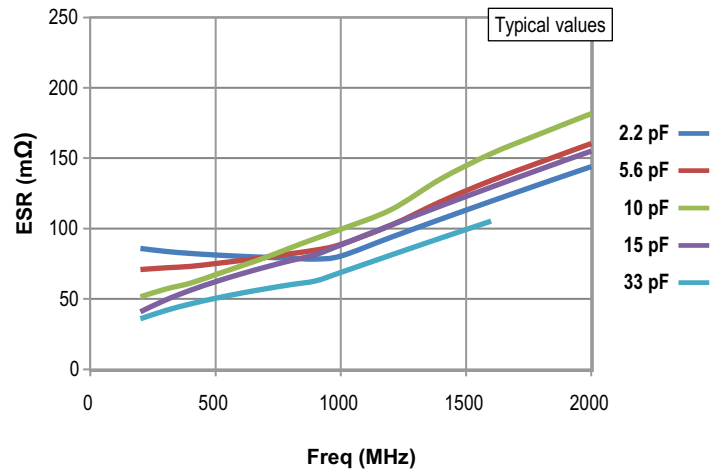

0402 - Q factor

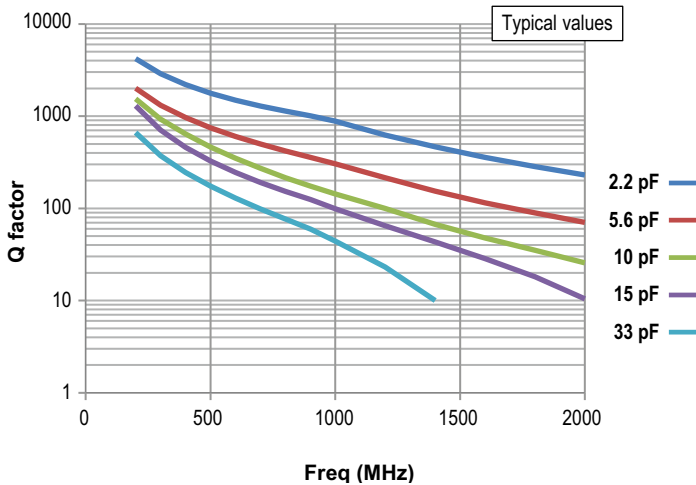

0402 - Max Current

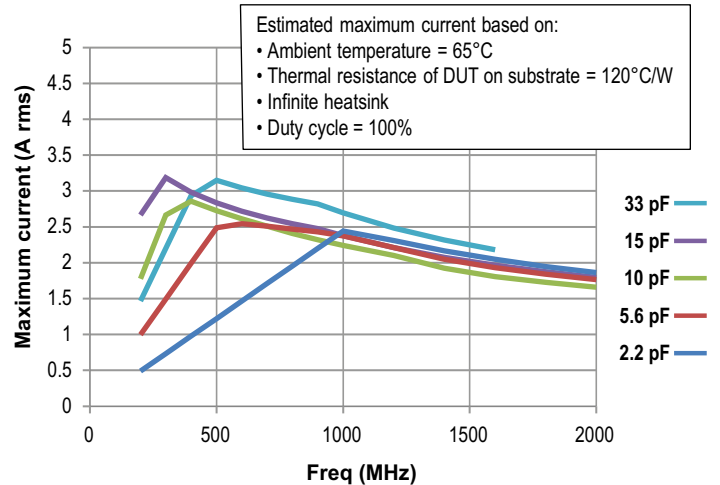

RF Capacitors

Multi-Layer High-Q, Ultra-Low Loss - 0603 Size

RF Characteristics

0603 - Resonant frequency

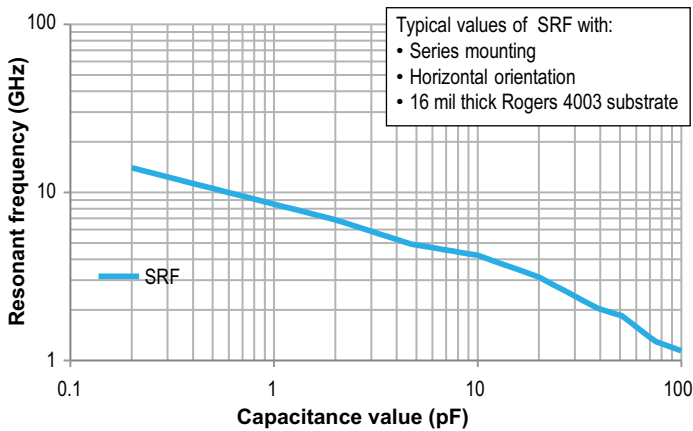

The Series Resonant Frequency is highly dependent on the substrate, pad dimensions, and measurement method. The above chart is for reference only.

0603 - Equivalent Series Resistance (ESR)

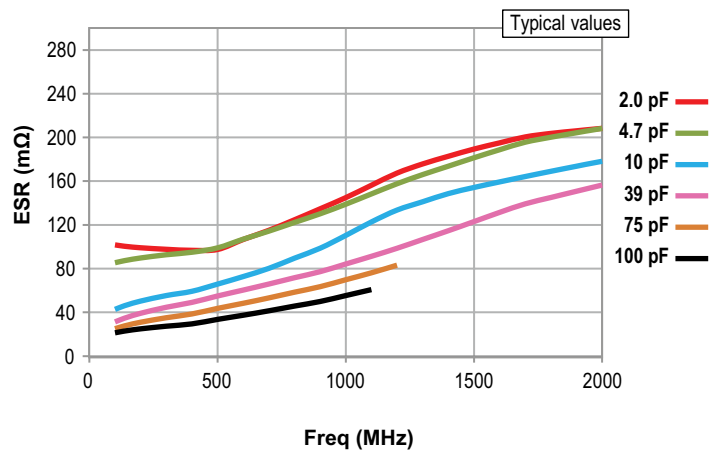

0603 - Q factor

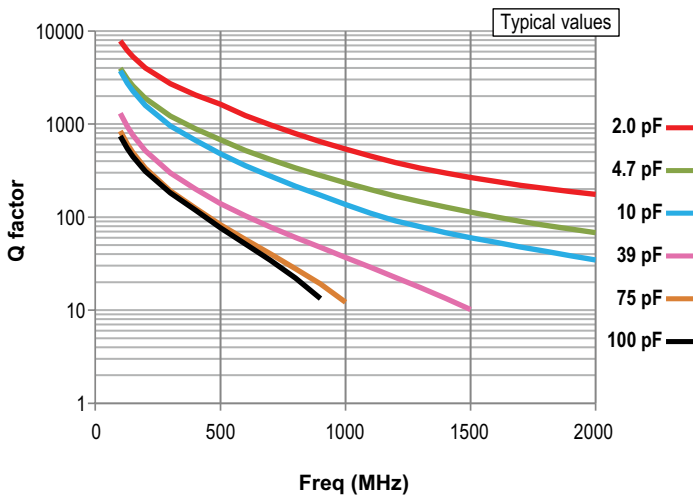

0603 - Max Current

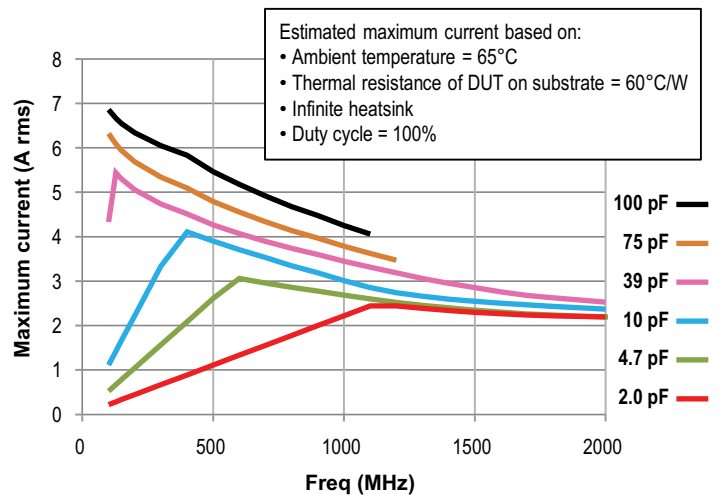

RF Capacitors - Characteristics

Multi-Layer High-Q, Ultra-Low Loss - 0805 Size

0805 - Resonant frequency

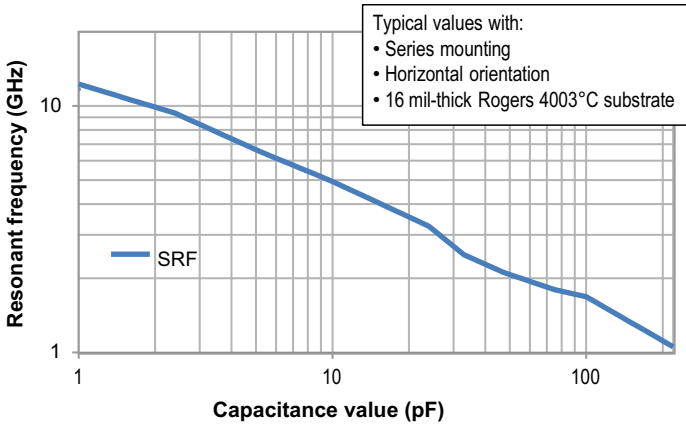

The Series Resonant Frequency is highly dependent on the substrate, pad dimensions, and measurement method. The above chart is for reference only.

0805 - Equivalent Series Resistance (ESR)

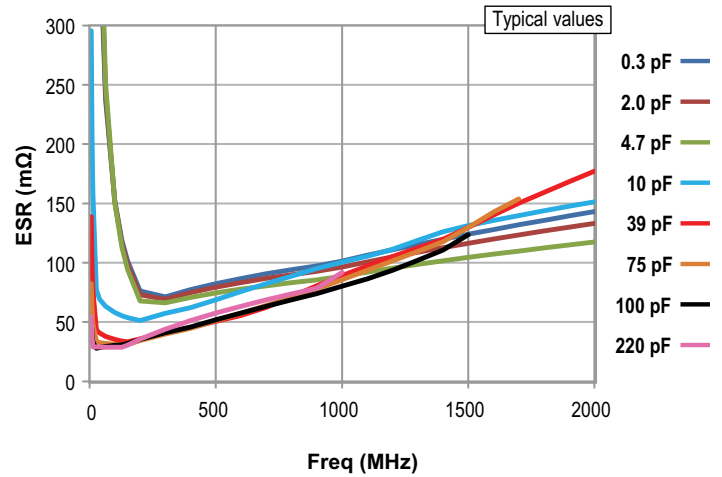

0805 - Q factor

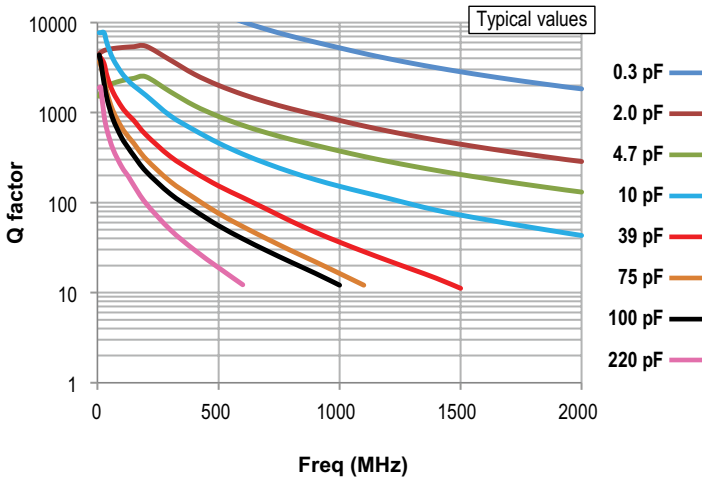

0805 - Effective capacitance value

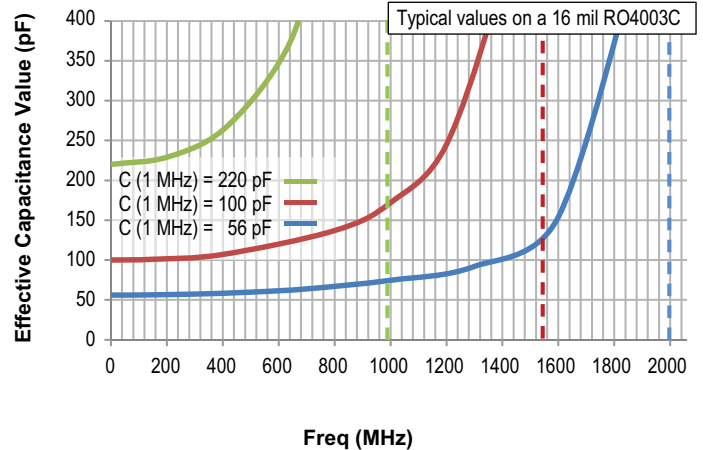

0805 - Max Current vs. Cap. Value

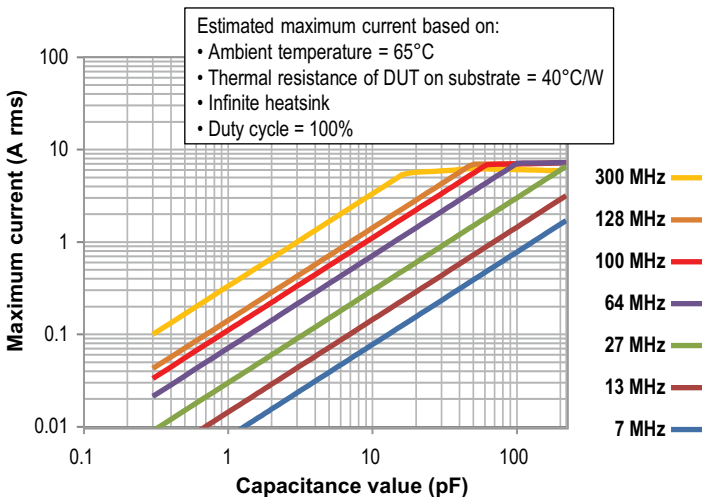

0805 - Max Current vs. Frequency

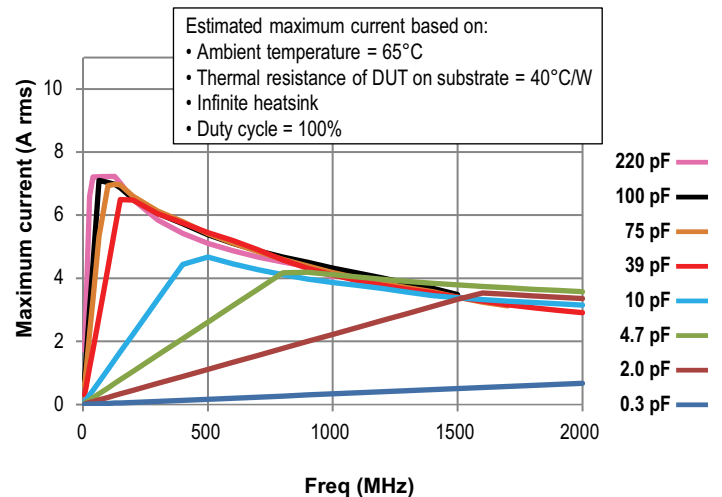

RF Capacitors - Characteristics

Multi-Layer High-Q, Ultra-Low Loss - 1111 Size

1111 - Resonant frequency

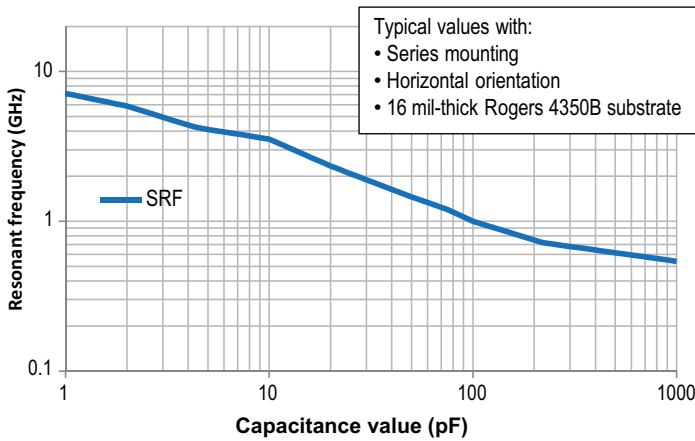

The Series Resonant Frequency is highly dependent on the substrate, pad dimensions, and measurement method. The above chart is for reference only.

1111 - Equivalent Series Resistance (ESR)

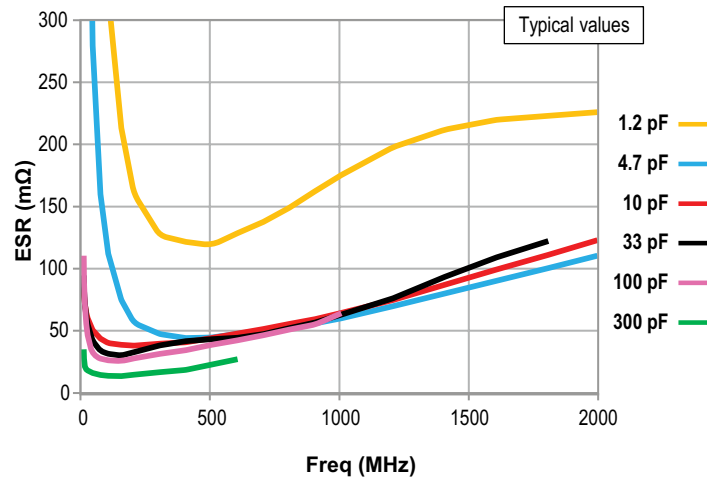

1111 - Q factor

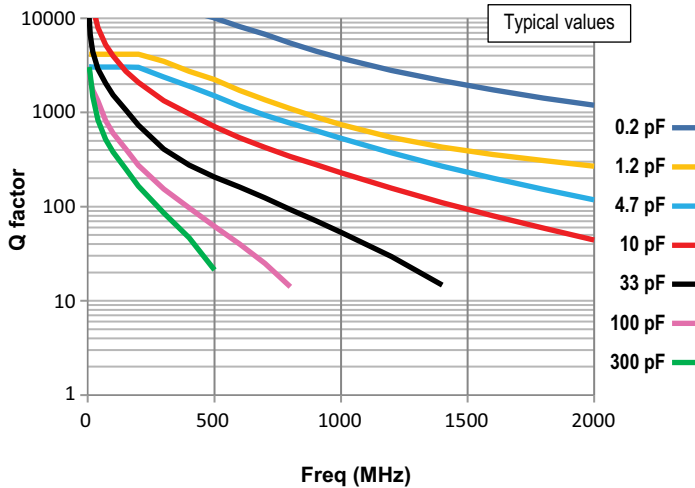

1111 - Effective capacitance value

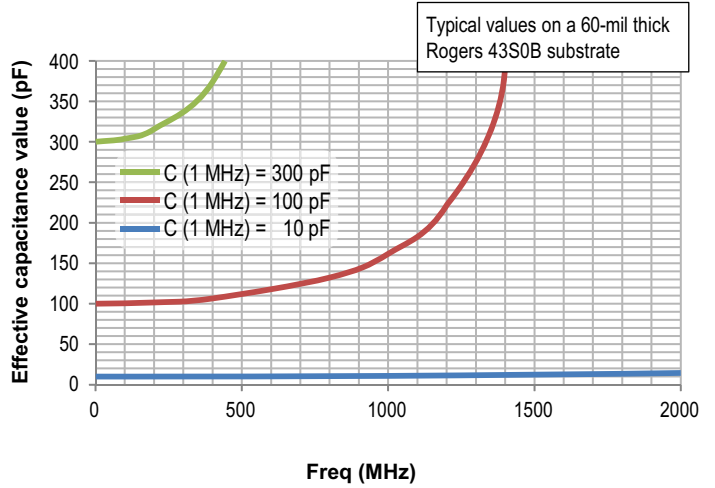

1111 - Max Current vs. Capacitance Value

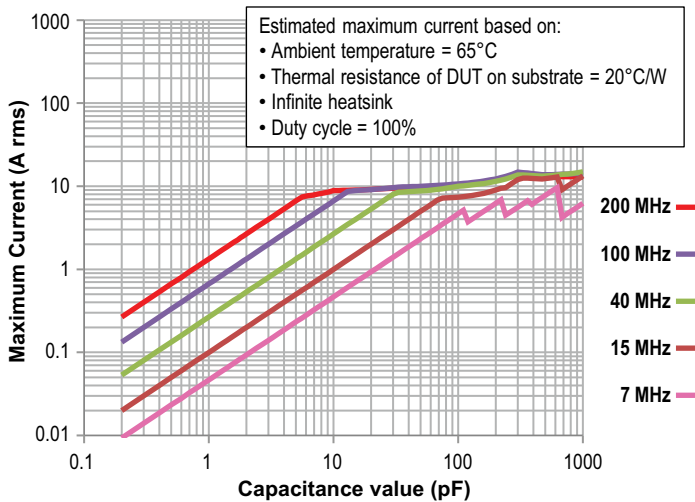

1111 - Max Current vs. Frequency

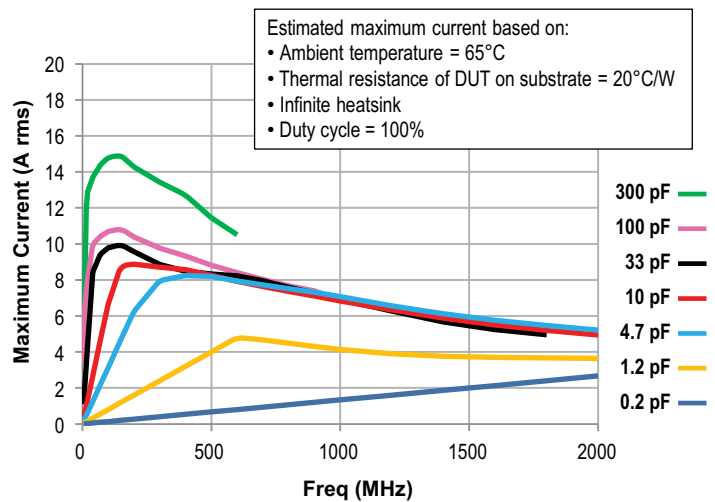

RF Characteristics

2525 - Series Resonant Frequency

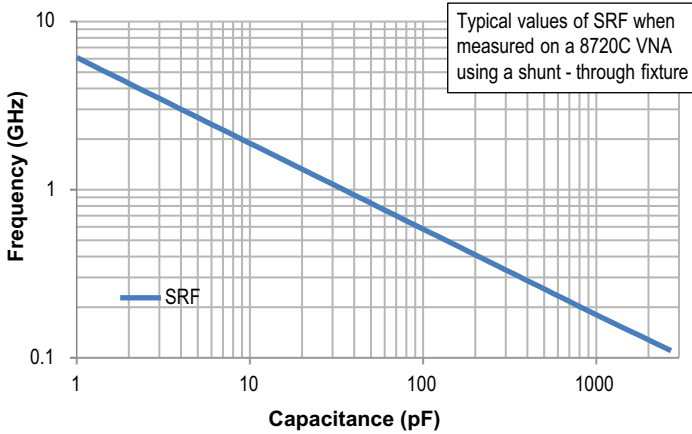

The Series Resonant Frequency is highly dependent on the substrate, pad dimensions, and measurement method. The above chart is for reference only.

2525 - Equivalent Series Resistance (ESR)

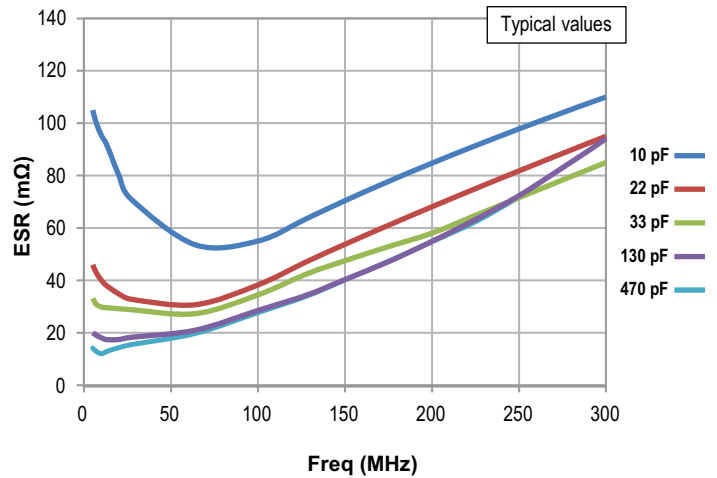

2525 - Q factor

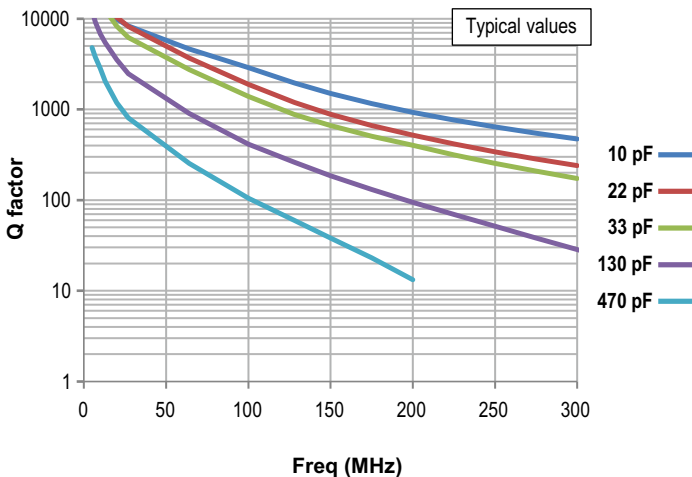

2525 - Max Current vs. Frequency

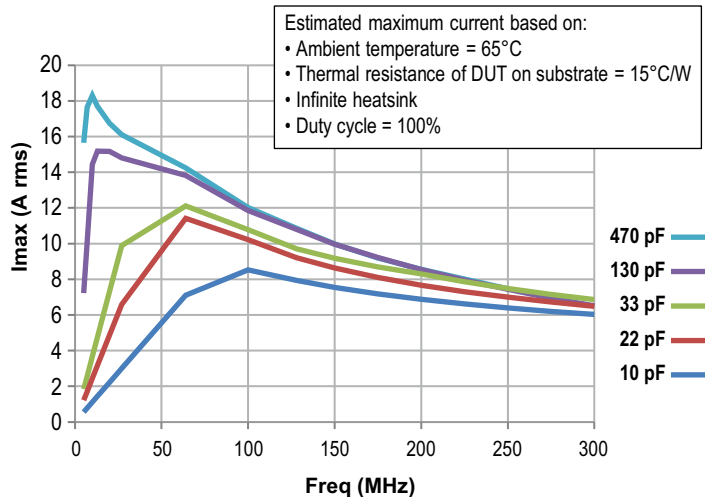

RF Capacitors

Multi-Layer High-Q, Ultra-Low Loss - 3838 Size

RF Characteristics

3838 - Resonant Frequency

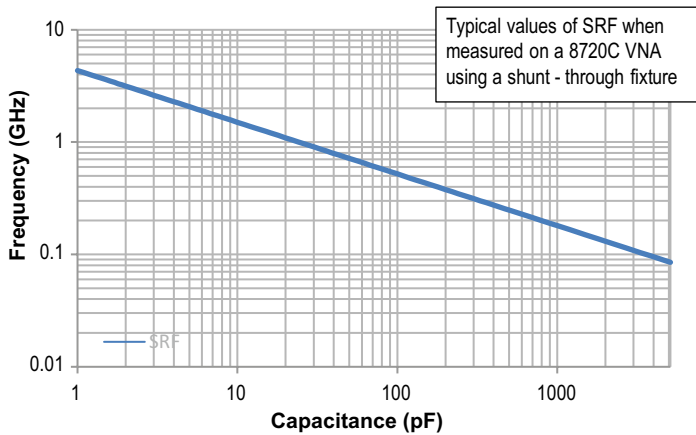

The Series Resonant Frequency is highly dependent on the substrate, pad dimensions, and measurement method. The above chart is for reference only.

3838 - Equivalent Series Resistance (ESR)

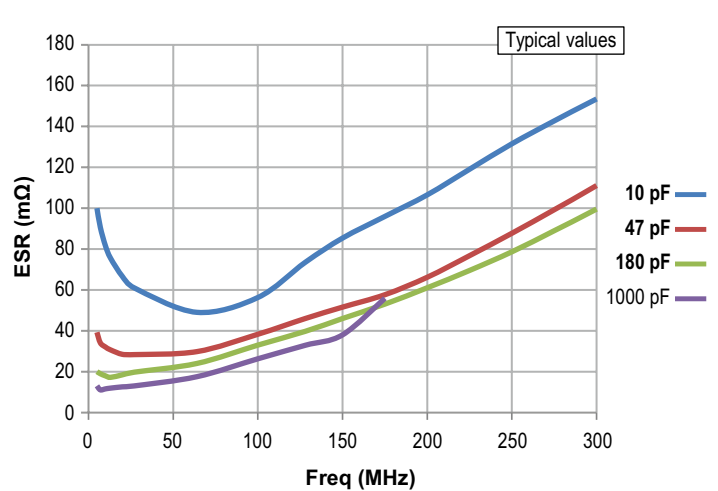

3838 - Q factor

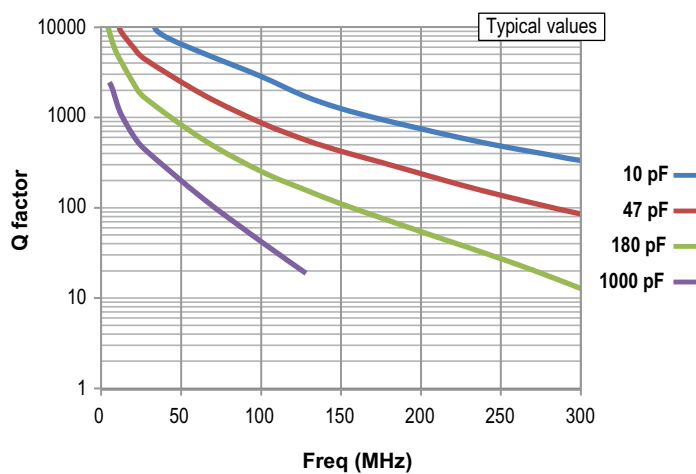

3838 - Max Current vs. Frequency

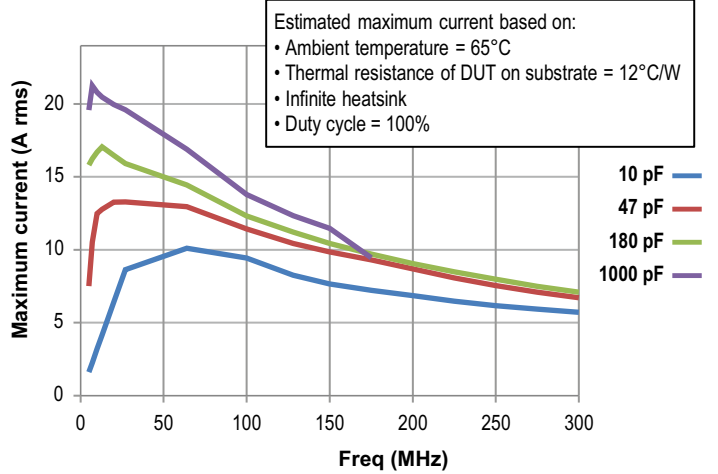



RF Capacitors

Power High-Q, & High Voltage Assemblies

Semiconductor Process Equipment

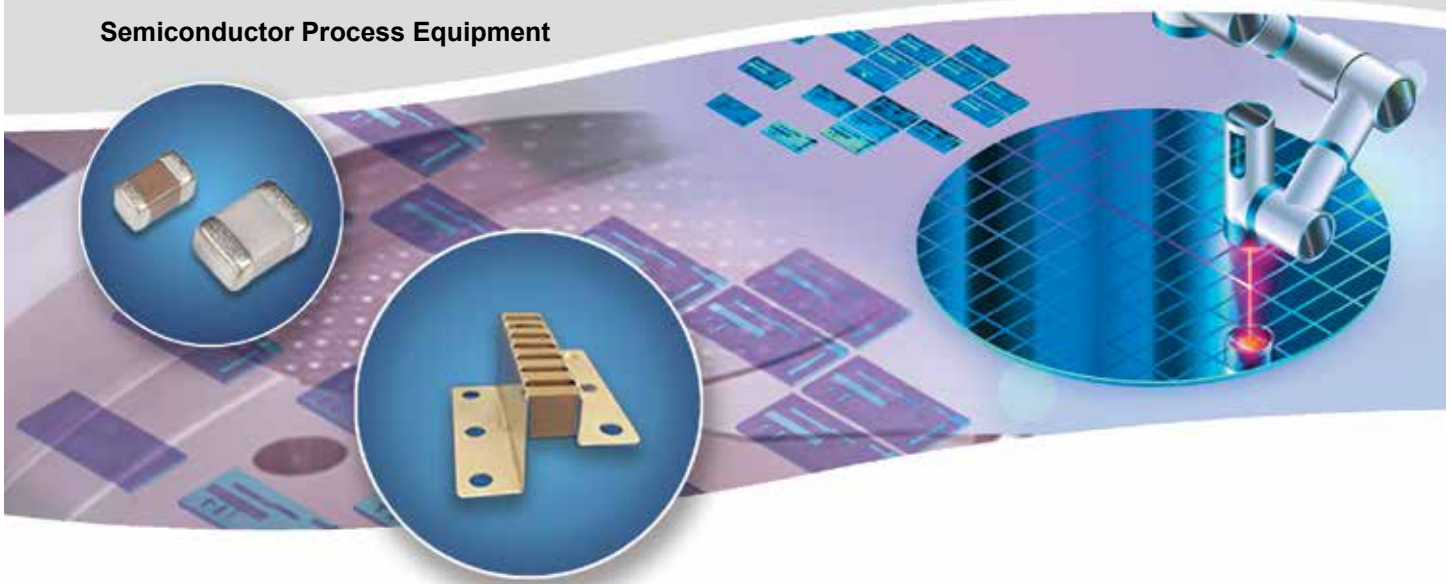

Optimized to meet your specific requirements. Our engineers will work with you to optimize the design, evaluate trade-offs (dimensions, cost, voltage, power and more). [Contact Johanson engineers for your specific needs.](#)

Features:

- NP0/COG Temperature Stability
- Conformal Quoting When Required
- Made with High Temperature Solder (melting point near 300°C)
- Matched Capacitance Tolerances
- Many Possible Materials, and Plating Types for the Leads
- Consistent Performance Lot-to-Lot, Month-to-Month

Common Applications:

- RF Power Generators
- MRI Transmit Coil
- RF Induction Heating
- RF Plasma Generator
- RF Power Amplifiers
- Matching Box

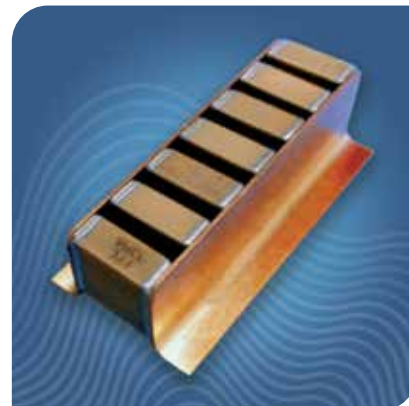



Capacitors

High Temperature - Chips 200°C, SMT



Features:

- Stable 200°C Operation
- Compact SMD Chip
- DC Voltage Ratings 50, 100, 200V
- Polyterm® Termination Option
- Sn-Pb Termination Option
- Class I and Class II Available
- Operating Temperature Range: -55°C to +200°C
- RoHs Compliant

Common Applications:

- Down Hole / Drilling Electronics
- High Temperature Modules
- Industrial Equipment

Electrical Characteristics

Type	NP0	X7R
Operating Range:	-55 to +200°C	-55 to +200°C
Temperature Coefficient:	0±30ppm/°C (-55to+125°C)	0±15% (-55to+125°C)
200°C Cap. Drop:	-0.5% max.	-45% max.
Dissipation Factor:	0.001 (0.1%) max.	0.020 (2.0%) max.
Aging Rate:	None	<1.0% per decade
Insulation Resistance:	25°C IR >100GΩ or 1000QF (whichever is less) 200°C IR >1QF or 100MΩ is less	
Withstanding Voltage:	2.5 X WVDC for ratings ≤ 200 VDC 1.5 X WVDC for ratings 201-500 VDC	
Test Conditions:	C > 100 pF; 1kHz ±50Hz; 1.0±0.2 VRMS C ≤ 100 pF; 1Mhz ±50kHz; 1.0±0.2 VRMS	

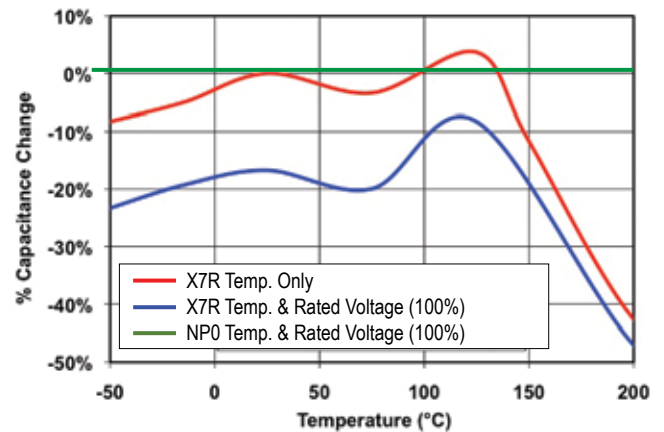

HOW TO ORDER

HU	CP	500	W	103	K	1	GV	001	B
Subfamily	Size	Voltage	DTC	Capacitance	Tol	Mark	Termination	Special Code	Pack
HU = High Temp Chips 200°	CF = 0402 CP = 0603 CT = 0805 DD = 1206 DF = 1210 DR = 1812 DV = 1825 EH = 2225	250 = 25 V 500 = 50 V 101 = 100 V 201 = 200 V	G = NP0/COG W = X7R	1st two digits are significant; third digit denotes number of zeros. 102 = 1000 pF 103 = 0.01 μF 104 = 0.10 μF	NP0 J = ± 5% K = ± 10% X7R K = ± 10% M = ± 20%	1 = No Mark	GV = Ni/Sn (RoHS) NT = Ni/SnPb GP = Pd/Ag (RoHS)	001 = Special Code	E = 7" Reel Emb Tape T = 7" Reel Paper Tape

Example: **HUCP500W103K1GV001B** Capacitors High-Temp Chips 200°, 0603, X7R, 50V, 0.01μF±10%, Ni/Sn (RoHS), Bulk









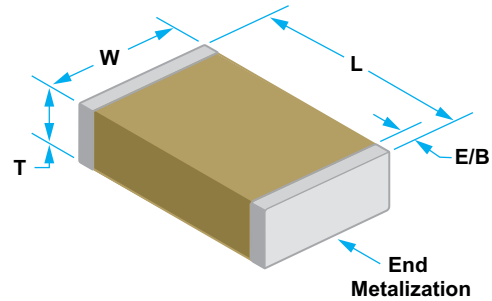

Capacitors

High Temperature - Chips 200°C, SMT

Mechanical Characteristics



EIA	RATED VOLTAGE	NP0 DIELECTRIC		X7R DIELECTRIC	
		MINIMUM	MAXIMUM	MINIMUM	MAXIMUM
 0402 / CF	25 VDC 50 VDC 100 VDC 200 VDC	10 pF 10 pF 10 pF 10 pF	270 pF 120 pF 82 pF 50 pF	100 pF 100 pF 10 pF 10 pF	4700 pF 1500 pF 390 pF 100 pF
 0603 / CP	25 VDC 50 VDC 100 VDC	10 pF 10 pF 10 pF 10 pF	820 pF 330 pF 220 pF 120 pF	1000 pF 1000 pF 100 pF 100 pF	0.022 pF 0.010 pF 2200 pF 560 pF
 0805 / CT	25 VDC 50 VDC 100 VDC 200 VDC	100 pF 100 pF 100 pF 10 pF	2200 pF 1500 pF 1000 pF 680 pF	1000 pF 1000 pF 1000 pF 100 pF	0.100 μF 0.033 μF 0.010 μF 2200 pF
 1206 / DD	25 VDC 50 VDC 100 VDC 200 VDC	100 pF 100 pF 100 pF 100 pF	6800 pF 3300 pF 2200 pF 1500 pF	1000 pF 1000 pF 1000 pF 1000 pF	0.220 μF 0.100 μF 0.022 μF 5600 pF
 1210 / DF	25 VDC 50 VDC 100 VDC 200 VDC	1000 pF 1000 pF 100 pF 100 pF	0.015 μF 5600 pF 4700 pF 3300 pF	0.047 μF 0.047 μF 0.047 μF 0.0047 μF	0.470 μF 0.220 μF 0.056 μF 0.015 μF
 1812 / DR	25 VDC 50 VDC 100 VDC 200 VDC	1000 pF 1000 pF 1000 pF 1000 pF	0.033 μF 0.012 μF 0.010 μF 8200 pF	0.033 μF 0.012 μF 0.010 μF 8200 μF	1.000 μF 0.470 μF 0.180 μF 0.047 μF
 1825 / DV	25 VDC 50 VDC 100 VDC 200 VDC	1000 pF 1000 pF 1000 pF 1000 pF	0.033 μF 0.027 μF 0.022 μF 0.018 μF	0.10 μF 0.10 μF 0.10 μF 0.10 μF	2.200 μF 1.000 μF 0.560 μF 0.150 μF
 2225 / EH	25 VDC 50 VDC 100 VDC 200 VDC	1000 pF 1000 pF 1000 pF 1000 pF	0.100 μF 0.039 μF 0.033 μF 0.022 μF	0.10 μF 0.10 μF 0.10 μF 0.10 μF	3.300 μF 1.500 μF 0.820 μF 0.220 μF



Capacitors - High Temperature Radial Leaded 200°C Rated

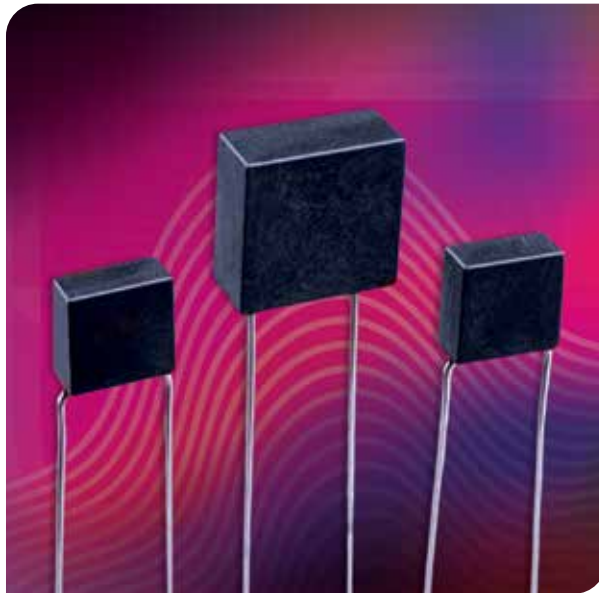

Features:

- For use at Temperature Up to 200°C
- Dielectric Type: NP0, X7R
- Capacitance Range: 200pF-3.9pF
- Rated Working Voltages from 50V to 4KV
- Rugged Premolded Case with Hi-Temp Epoxy Fill
- Compact MLC Designs Utilizing Military Grade Ceramics
- Custom Sizes, Values, and Voltages Available

Common Applications:

- Oil Well Logging (Down-hole)
- Geophysical Probes
- Jet Engine Controls

Dielectric	NP0 Dielectric	X7R Dielectric
Temperature Coefficient	0 ± 30ppm/°C, -55 to 125°C	± 15% -55 to 125°C
Capacitance Drop at 200°C	minus 0.5% max	minus 45% max
Dissipation Factor	.001 (0.1%)max, 1Khz, 25°C	.025 (2.5%)max, 1Khz, 25°C
Insulation Resistance at 25°C	1000 ΩF or 100 GΩ, whichever is less @ 25°C, WVDC	1000 ΩF or 100 GΩ, whichever is less @ 25°C, WVDC
Insulation Resistance at 200°C	1 ΩF or 100 GΩ, whichever is less @ 200°C, WVD	1 ΩF or 100 GΩ, whichever is less @ 200°C, WVDC
For 25-200V Ratings	2.5 X WVDC, 25°C, 50 mA max	2.5 X WVDC, 25°C, 50 mA max
For 500V Ratings	1.5 X WVDC, 25°C, 50 mA max	1.5 X WVDC, 25°C, 50 mA max
For 1-4 KV Ratings	1.2 X WVDC, 25°C, 50 mA max	1.2 X WVDC, 25°C, 50 mA max

HOW TO ORDER

HP	EY	102	G	223	M	Z	QA	001	B
Subfamily	Size	Voltage	DTC	Capacitance	Tol	Mark	Termination	Special Code	Pack
HP = High Temp Radial 200°C	See chart	500 = 50V 101 = 100V 201 = 200V 501 = 500V 102 = 1KV 202 = 2KV 302 = 3KV 402 = 4KV	G = NP0/COG W = X7R	1st two digits are significant; 3rd digit denotes number of zeros. 102 = 1000 pF 103 = 0.01 μF 104 = 0.10 μF	NP0 J = ±5% K = ±10% X7R K = ±10% M = ±20%	3 = Cap Code & Tol Z = Special Code	QA = Blk composite case w/ Radial Wire (Ni/SnPb)	001 = No mark	B = Bulk C = Non-conductive bags

Example: **HPEY102G223MZQA001B** Capacitors High-Temperature Radial 200°, 2833, NP0/COG, 1,000.0V, 0.022μF±20%, Black Composite Case w/ Radial Wire (Ni/SnPb), Bulk

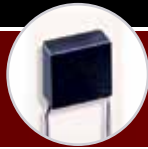

Capacitors - High Temperature
Radial Leaded 200°C Rated

Capacitance & Voltage Selection

Code	EIA Size		T	W	G	S	d (Dia.)	Diel	Maximum Capacitance								
									25V	50V	100V	200V	500V	1KV	2KV	3KV	4KV
DH	1316	in	0.100	0.200	0.200	0.100	.020	NP0	223	153	902	502	302	152	561	221	560
		mm	(2.54)	(5.08)	(5.08)	(2.54)	(0.51)	X7R	334	224	125	563	303	103	262	391	121
DH	1316	in	.100	.200	.200	.170	.020	NP0	223	153	902	502	302	152	561	221	560
		mm	(2.54)	(5.08)	(5.08)	(4.32)	(0.51)	X7R	334	224	124	563	303	103	262	391	121
DH	1316	in	0.100	0.200	0.200	0.200	0.020	NP0	223	153	902	52	302	152	561	221	560
		mm	(2.54)	(5.08)	(5.08)	(5.08)	(0.51)	X7R	334	224	124	563	303	103	262	391	121
EK	2322	in	0.100	0.300	0.300	0.200	0.020	NP0	603	503	283	163	103	682	222	102	301
		mm	(2.54)	(7.62)	(7.62)	(5.08)	(0.51)	X7R	105	105	394	224	104	123	472	102	221
EK	2322	in	0.150	0.300	0.300	0.200	0.020	NP0	823	623	423	343	203	133	432	222	561
		mm	(3.81)	(7.62)	(7.62)	(5.08)	(0.51)	X7R	563	125	824	464	241	563	203	332	102
ET	2522	in	0.250	0.320	0.300	0.200	0.020	NP0	823	683	483	373	273	183	822	362	102
		mm	(6.35)	(8.13)	(7.62)	(5.08)	(0.51)	X7R	155	155	94	624	404	124	393	822	822
EY	2833	in	0.275	0.350	0.400	0.300	0.020	NP0	124	104	803	623	503	333	153	562	152
		mm	(6.99)	(8.89)	(10.16)	(7.62)	(0.51)	X7R	225	225	165	105	724	274	732	153	472
FJ	3533	in	0.250	0.420	0.400	0.300	0.025	NP0	154	124	104	683	563	393	163	103	272
		mm	(6.35)	(10.67)	(10.16)	(7.62)	(0.64)	X7R	335	305	205	125	724	334	753	223	562
FT	3844	in	0.300	0.450	0.500	0.300	0.025	NP0	224	224	164	124	783	563	293	103	392
		mm	(7.62)	(11.43)	(12.7)	(7.62)	(0.64)	X7R	445	45	305	25	125	564	144	333	103
FX	3945	in	0.100	0.500	0.500	0.400	0.025	NP0	334	184	14	683	413	273	682	392	152
		mm	(2.54)	(12.7)	(12.7)	(10.16)	(0.64)	X7R	475	405	125	724	404	104	333	822	222
FX	3945	in	0.150	0.500	0.500	0.400	0.025	NP0	304	254	184	124	803	473	103	822	822
		mm	(3.81)	(12.7)	(12.7)	(10.16)	(0.64)	X7R	555	505	335	155	724	224	683	203	562
FX	3945	in	0.200	0.500	0.500	0.400	0.025	NPO	304	254	184	144	104	683	223	123	332
		mm	(5.08)	(12.7)	(12.7)	(10.16)	(0.64)	X7R	555	505	275	225	105	394	104	303	103
FX	3945	in	0.250	0.500	0.500	0.400	0.025	NPO	304	254	184	144	104	823	273	153	392
		mm	(6.35)	(12.7)	(12.7)	(10.16)	(0.64)	X7R	555	505	275	225	105	474	104	223	103
FX	3945	in	0.300	0.520	0.500	0.400	0.025	NPO	304	254	224	154	104	823	333	153	492
		mm	(7.62)	(13.21)	(12.7)	(10.16)	(0.64)	X7R	555	505	275	225	105	564	154	473	153
GD	4354	in	0.400	0.600	0.700	0.500	0.025	NPO	424	324	224	184	124	104	563	203	822
		mm	(10.16)	(15.24)	(17.78)	(12.7)	(0.64)	X7R	625	445	405	305	225	105	274	683	222
HJ	5364	in	0.375	0.650	0.700	0.600	0.025	NPO	564	484	334	224	204	154	823	333	153
		mm	(9.53)	(16.51)	(17.78)	(15.24)	(0.64)	X7R	106	805	525	485	305	125	474	124	333
HB	5044	in	0.300	0.620	0.500	0.500	0.025	NPO	394	304	224	184	124	104	563	223	103
		mm	(7.62)	(15.75)	(12.7)	(12.7)	(0.64)	X7R	705	605	405	305	205	684	274	683	183
HQ	5733	in	0.200	0.700	0.400	0.500	0.025	NPO	334	274	184	154	114	823	333	153	472
		mm	(5.08)	(17.78)	(10.16)	(12.7)	(0.64)	X7R	625	505	335	255	125	474	154	393	103
HT	5964	in	0.300	0.720	0.700	0.600	0.025	NPO	684	504	404	304	224	184	823	393	183
		mm	(7.62)	(18.29)	(17.78)	(15.24)	(0.64)	X7R	126	106	725	565	335	125	474	124	333
JD	6374	in	0.375	0.750	0.800	0.700	0.025	NPO	684	564	474	394	294	274	124	473	273
		mm	(9.53)	(19.05)	(20.32)	(17.78)	(0.64)	X7R	156	126	985	625	425	225	684	224	473
JJ	6964	in	0.350	0.820	0.700	0.700	0.025	NPO	624	564	474	374	284	224	124	473	273
		mm	(8.89)	(20.83)	(17.78)	(17.78)	(0.64)	X7R	126	106	825	565	405	225	684	224	473



Capacitors
Radial Leaded (Switchmode)

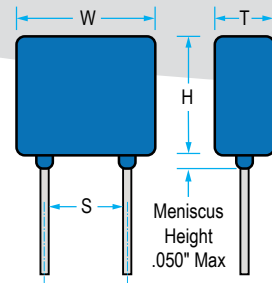
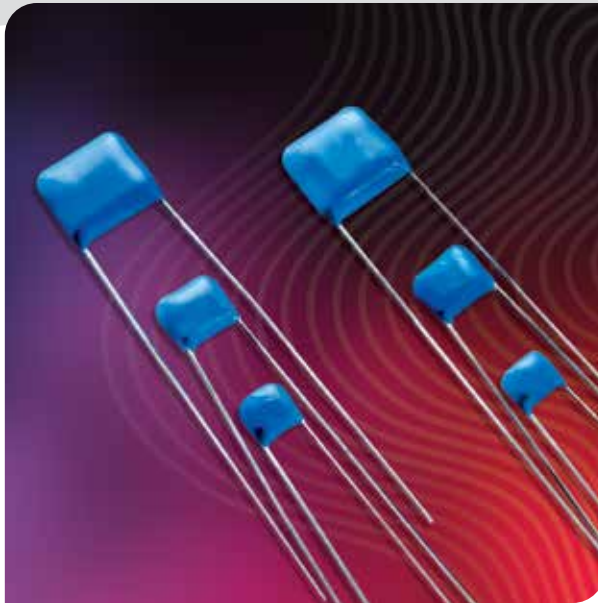





Features:

- Rated Working Voltages from 25 to 500 VDC
- Rugged Epoxy Coating Offers Increased Protection
- Hi-Rel Screened Versions Available
- Custom Sizes, Voltages, and Values Available

Common Applications:

- Power Supplies
- Data Isolation
- Industrial Control Circuits
- Voltage Multipliers
- Surge Protection
- Custom Applications





Code / EIA Size		Inches	Millimeters	RATED VOLTAGE	NP0 Capacitance (MAX.)		X7R Capacitance (MAX.)	
					VALUE	CODE	VALUE	CODE
 DT / 1820	W	.300 max.	(7.62 max.)	25 VDC	.070 μ F	703	2.00 μ F	205
	H	.300 max.	(7.62 max.)	50 VDC	.060 μ F	603	1.60 μ F	165
	T	.200 max.	(5.08 max.)	100 VDC	.050 μ F	503	1.10 μ F	115
	S	.200 nom.	(5.08 nom.)	200 VDC	.040 μ F	403	.730 μ F	734
	LD	.020 nom.	(.510 nom.)	500 VDC	.020 μ F	203	.250 μ F	254
 EX / 2830	W	.400 max.	(10.2 max.)	25 VDC	.120 μ F	124	5.10 μ F	515
	H	.400 max.	(10.2 max.)	50 VDC	.100 μ F	104	4.10 μ F	415
	T	.200 max.	(5.08 max.)	100 VDC	.082 μ F	823	2.70 μ F	275
	S	.200 nom.	(5.08 nom.)	200 VDC	.050 μ F	503	1.80 μ F	185
	LD	.020 nom.	(.510 nom.)	500 VDC	.030 μ F	303	.670 μ F	674
 FR / 3840	W	.500 max.	(12.7 max.)	25 VDC	.240 μ F	244	8.70 μ F	875
	H	.500 max.	(12.7 max.)	50 VDC	.200 μ F	204	7.20 μ F	725
	T	.200 max.	(5.08 max.)	100 VDC	.180 μ F	184	4.80 μ F	485
	S	.400 nom.	(10.2 nom.)	200 VDC	.110 μ F	114	3.30 μ F	335
	LD	.025 nom.	(.635 nom.)	500 VDC	.070 μ F	703	1.10 μ F	115
 KD / 7450	W	.870 max.	(22.1 max.)	25 VDC	.750 μ F	754	22.0 μ F	226
	H	.600 max.	(15.2 max.)	50 VDC	.620 μ F	624	17.0 μ F	176
	T	.200 max.	(5.08 max.)	100 VDC	.560 μ F	564	13.0 μ F	136
	S	.790 nom.	(20.1 nom.)	200 VDC	.360 μ F	364	8.00 μ F	805
	LD	.032 nom.	(.813 nom.)	500 VDC	.240 μ F	244	2.90 μ F	295

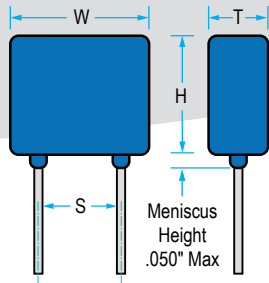

Capacitors Radial Leaded (Switchmode)



NOTE: Lead lengths are typically 1.25" for orders in bulk packaging.
Leads are typically 1.00" for tape and reel packaging.
Tape and reel packaging comes in 1000 piece reels.
LD = Lead Diameter.

Code / EIA Size	Inches	Millimeters	Rated Voltage	NP0 Capacitance (Max.)		X7R Capacitance (Max.)		
				VALUE	CODE	VALUE	CODE	
 MD / 9750	W H T S LD	1.10 max. .600 max. .200 max. .980 nom. .032 nom.	(27.9 max.) (15.2 max.) (5.08 max.) (24.9 nom.) (.813 nom.)	25 VDC	.680 μ F	684	35.0 μ F	356
				50 VDC	.560 μ F	564	28.0 μ F	286
				100 VDC	.470 μ F	474	19.0 μ F	196
				200 VDC	.330 μ F	334	13.0 μ F	136
				500 VDC	.200 μ F	204	4.60 μ F	465
 MD / 9750	W H T S LD	1.10 max. .600 max. .350 max. .980 nom. .032 nom.	(27.9 max.) (15.2 max.) (8.89 max.) (24.9 nom.) (.813 nom.)	25 VDC	1.20 μ F	125	70.0 μ F	706
				50 VDC	1.10 μ F	115	56.0 μ F	566
				100 VDC	.820 μ F	824	37.0 μ F	376
				200 VDC	.470 μ F	474	26.0 μ F	266
				500 VDC	.300 μ F	304	8.70 μ F	875
 HF / 5344	W H T S LD	.670 max. .540 max. .200 max. .575 nom. .025 nom.	(17 max.) (13.7 max.) (5.08 max.) (14.6 nom.) (.635 nom.)	25 VDC	.450 μ F	454	13.0 μ F	136
				50 VDC	.360 μ F	364	10.0 μ F	106
				100 VDC	.330 μ F	334	7.20 μ F	725
				200 VDC	.240 μ F	244	5.00 μ F	505
				500 VDC	.180 μ F	184	1.70 μ F	175
 LF / 8060	W H T S LD	.930 max. .720 max. .250 max. .800 nom. .032 nom.	(23.6 max.) (18.3 max.) (6.35 max.) (20.3 nom.) (.813 nom.)	25 VDC	1.00 μ F	105	38.0 μ F	386
				50 VDC	.900 μ F	904	30.0 μ F	306
				100 VDC	.750 μ F	754	20.0 μ F	206
				200 VDC	.470 μ F	474	14.0 μ F	146
				500 VDC	.300 μ F	304	5.80 μ F	585

HOW TO ORDER

RL	MF	201	G	823	M	3	RN	001	T
Subfamily	Size	Voltage	Dielectric	Capacitance	Tolerance	Mark	Termination	Special Code	Packing
RL = Radial Leaded	See Chart	250 = 25 V 500 = 50 V 101 = 100 V 201 = 200 V 501 = 500 V	G = NP0/C0G W = X7R	1st two digits are significant; 3rd digit denotes number of zeros. 101 = 100 pF 103 = 0.01 μ F 105 = 1.00 μ F	J = \pm 5% K = \pm 10% M = \pm 20% Z = +80% -20%	3 = Cap Code & Tol Z = Special Code	QN = Radial Wire Encap (Ni/SnPb) QR = Radial Wire Encap (Ni/Sn RoHS) RR = Radial Wire (Ni/Sn RoHS) RN = Radial Wire (Ni/SnPb)	001 = Default catalog item	B = Bulk T = 7" Reel Paper Tape Z = Special

Example: **RLMF201G823M3RN001T** Capacitors Radial Leaded, Special, NP0/C0G cap, 200.0V, 0.08 μ F \pm 20% cap, Radial Wire (Ni/SnPb), 7" Reel Paper Tape cap



Capacitors Radial Leaded (High Voltage)

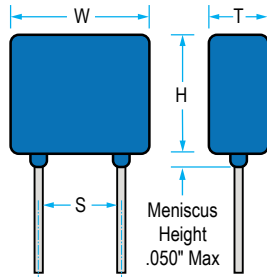





Features:

- Rated Working Voltages from 500 to 5000 VDC
- Rugged Epoxy Coating Offers Increased Protection
- Compact MLC Designs Smaller Than Film or Disc
- NEW 200°C Versions Available for Oil & Geophysical Tool, Aircraft Engine Control Applications
- DSCC Drawing & Other Screened Versions Available

Common Applications:

- Power Supplies
- Data Isolation
- Industrial Control Circuits
- Voltage Multipliers
- Surge Protection
- Custom Applications



Code / EIA Size	Inches	Millimeters	RATED VOLTAGE	NP0 Capacitance (MAX.)		X7R Capacitance (MAX.)	
				VALUE	CODE	VALUE	CODE
 DM / 1515	W H T S LD	0.250 Max (6.35 Max) 0.220 Max (5.59 Max) 0.270 Max (6.86 Max) 0.170 ± 0.03 (4.32 ± 0.76) 0.025 ± .002 (0.64 ± 0.05)	500 VDC	4700 pF	472	.150 µF	154
			1000 VDC	1500 pF	152	.055 µF	553
			2000 VDC	680 pF	681	9000 pF	902
			3000 VDC	330 pF	331	2800 pF	282
			4000 VDC	150 pF	151	630 pF	631
			5000 VDC	100 pF	101	550 pF	531
 ER / 2520	W H T S LD	0.370 Max (9.40 Max) 0.300 Max (7.62 Max) 0.270 Max (6.86 Max) 0.275 ± 0.03 (6.99 ± 0.76) 0.025 ± .002 (0.64 ± 0.05)	500 VDC	.022 µF	223	.480 µF	484
			1000 VDC	3300 pF	332	.170 µF	174
			2000 VDC	1500 pF	152	.025 µF	253
			3000 VDC	680 pF	681	.011 µF	113
			4000 VDC	330 pF	331	1800 µF	182
			5000 VDC	220 pF	221	940 µF	941
 FH / 3530	W H T S LD	0.470 Max (12.0 Max) 0.400 Max (10.2 Max) 0.320 Max (8.13 Max) 0.375 ± 0.03 (9.53 ± 0.76) 0.025 ± .002 (0.64 ± 0.05)	500 VDC	.056 µF	563	1.20 µF	125
			1000 VDC	4700 pF	472	.450 µF	454
			2000 VDC	3300 pF	332	.094 µF	943
			3000 VDC	1500 pF	152	.043 µF	433
			4000 VDC	1000 pF	102	.010 µF	103
			5000 VDC	470 pF	471	4900 pF	492
 GF / 4540	W H T S LD	0.570 Max (14.5 Max) 0.500 Max (12.7 Max) 0.320 Max (8.13 Max) 0.475 ± 0.03 (12.1 ± 0.76) 0.025 ± .002 (0.64 ± 0.05)	500 VDC	.100 µF	104	2.20 µF	225
			1000 VDC	.010 µF	103	.804 µF	804
			2000 VDC	6800 pF	682	.240 µF	244
			3000 VDC	3300 pF	332	.073 µF	733
			4000 VDC	2200 pF	222	.028 µF	283
			5000 VDC	1000 pF	102	.013 µF	133

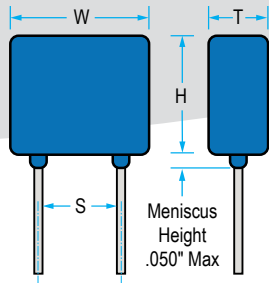

Capacitors Radial Leaded (High Voltage)



NOTE: Lead lengths are typically 1.25" for orders in bulk packaging.
Leads are typically 1.00" for tape and reel packaging.
Tape and reel packaging comes in 1000 piece reels.
LD = Lead Diameter.

Code / EIA Size	Inches	Millimeters	Rated Voltage	NP0 Capacitance (Max.)		X7R Capacitance (Max.)	
				VALUE	CODE	VALUE	CODE
 JF / 6560	W 0.770 Max H 0.720 Max T 0.320 Max S 0.675 ± 0.03 LD 0.025 ± .002	(19.6 Max) (18.3 Max) (8.13 Max) (17.1 ± 0.76) (0.64 ± 0.05)	500 VDC	.220 µF	224	5.70 µF	575
			1000 VDC	.022 µF	223	2.10 µF	215
			2000 VDC	.015 µF	153	.620 µF	624
			3000 VDC	6800 PF	682	.190 µF	194
			4000 VDC	4700 PF	472	.054 µF	543
			5000 VDC	3300 PF	332	.026 µF	263
 KF / 7565	W 0.870 Max H 0.750 Max T 0.320 Max S 0.775 ± 0.03 LD 0.025 ± .002	(22.1 Max) (19.1 Max) (8.13 Max) (19.7 ± 0.76) (0.64 ± 0.05)	500 VDC	.330 µF	334	7.30 µF	735
			1000 VDC	.100 µF	104	2.80 µF	285
			2000 VDC	.056 µF	563	.800 µF	804
			3000 VDC	.033 µF	333	.250 µF	254
			4000 VDC	.010 µF	103	.080 µF	803
			5000 VDC	6800 pF	682	.041 µF	413
 MK / 13060	W 1.450 Max H 0.720 Max T 0.320 Max S 1.375 ± 0.03 LD 0.025 ± .002	(36.8 Max) (18.3 Max) (8.13 Max) (34.9 ± 0.76) (.064 ± 0.05)	500 VDC	.470 µF	474	12.0 µF	126
			1000 VDC	.150 µF	154	4.60 µF	465
			2000 VDC	.082 µF	823	1.20 µF	125
			3000 VDC	.047 µF	473	.390 µF	394
			4000 VDC	.015 µF	153	.130 µF	134
			5000 VDC	.010 µF	103	.068 µF	683

HOW TO ORDER

RL	DM	501	G	222	K	3	RR	001	T
Subfamily	Size	Voltage	Dielectric	Capacitance	Tolerance	Mark	Termination	Special Code	Packing
RL = Radial Leaded	See Chart	501 = 500 V 102 = 1000 V 200 = 2000 V 302 = 3000 V 402 = 4000 V 502 = 5000 V	G = NP0/COG W = X7R	1st two digits are significant; 3rd digit denotes number of zeros. 101 = 100 pF 103 = 0.01 µF 105 = 1.00 µF	J = ± 5% K = ± 10% M = ± 20% Z = +80% -20%	3 = Cap Code & Tol Z = Special Code	QN = Radial Wire Encap (Ni/SnPb) QR = Radial Wire Encap (Ni/Sn RoHS) RR = Radial Wire (Ni/Sn RoHS) RN = Radial Wire (Ni/SnPb)	001 = Default catalog item	T = 7" Reel Paper Tape Z = Special

Example: **RLDM501G222K3RR001T** Capacitors H-Series Radial Leaded, 1515, NP0/COG cap, 500.0V, 2,200.00pF±10% cap, Radial Wire (Ni/Sn RoHS), 7" Reel Paper Tape cap



RF Capacitors
LASERtrim® (SMT RF Tuning)

LASERtrim® capacitors are laser adjustable monolithic ceramic surface mount devices for precise functional tuning of RF circuits. LASERtrims® have the high reliability expected of conventional multi-layer chip capacitors and do not experience capacitance drift, flux entrapment and other reliability concerns associated with mechanical trimmers. Excellent post-trim Q and ESR performance are exhibited at frequencies of 100 - 2000 MHz. Offered in chip sizes 0603 to 1210 with nickel barrier terminations and tape and reel packaging, LASERtrims® are compatible with high volume SMT auto-placement and reflow techniques. These high quality, drift-free devices are ideally suited for functional tuning applications in oscillator, filter, and antenna circuits in a variety of wireless RF products.

Features:

- RoHS Compliant Parts Available
- Automates Functional Tuning
- High Resolution, High Accuracy Tuning
- Highly Stable and Reliable After Adjustment
- Small, Standard SMD Chip Sizes
- Lower Placement Cost vs Mechanical

HOW TO ORDER

RoHS Part Number	EIA Case Size	Initial	Tuning Range	200 MHz
LTCP500G100R1GG001T	0603	10.0 pF	10.0 - 2.00 pF	> 125
LTCP500G120R1GG001T	0603	12.0 pF	12.0 - 2.00 pF	> 125
LTCT500G100R1GG001T	0805	10.0 pF	10.0 - 1.20 pF	> 75
LTCT500G200R1GG001T	0805	20.0 pF	20.0 - 1.50 pF	> 50
LTDF500G210R1GG001T	1210	21.0 pF	21.0 - 3.00 pF	> 75

Applications

Impedance Matching	Precision Frequency Matching	Custom Applications	Power Amplifier Matching
--------------------	------------------------------	---------------------	--------------------------



RF Capacitors LASERtrim® (SMT RF Tuning)

LASERtrim® tuning capacitors are used to provide functional RF circuitry tuning. The tuning is normally performed at a laser station integrated into the automated assembly line at a point beyond any operations that may significantly alter the circuit's RF characteristics. Tuning is performed by a computer controlled YAG laser beam which removes or "trims" the top electrode material of the LASERtrim® thereby decreasing its capacitance. Circuit parameters such as frequency or voltage are monitored during tuning and fed back to the laser controller achieving extremely precise results. Typical capacitance change in relation to the amount of electrode removal is shown in the graphs below.

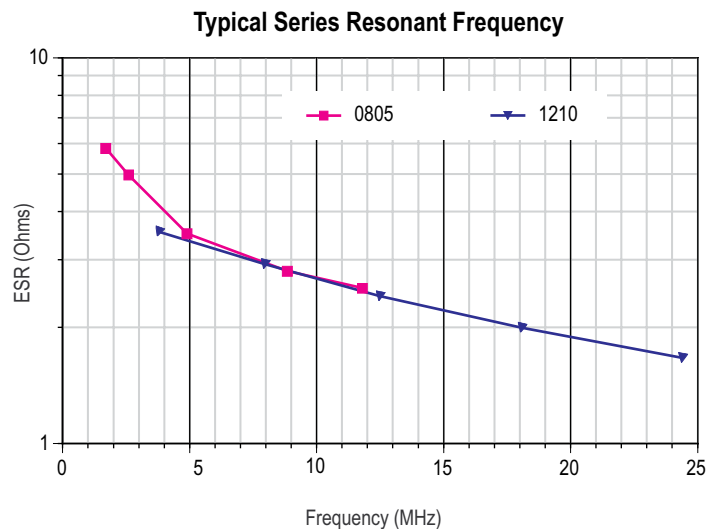
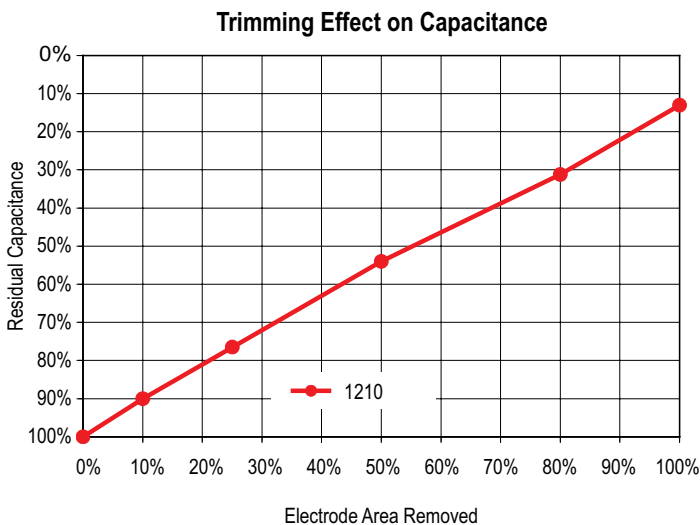
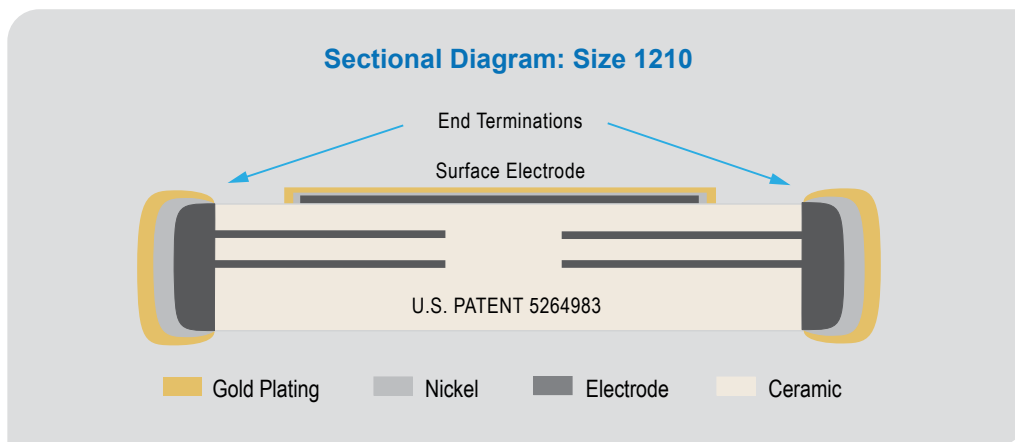
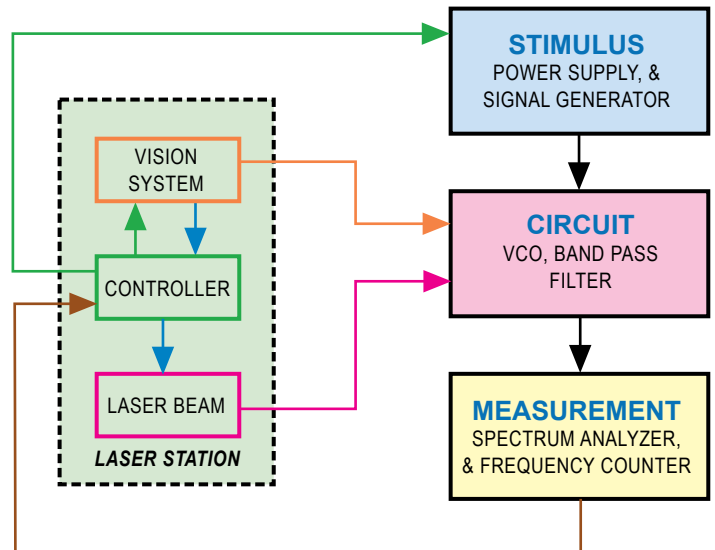



RF Capacitors
LASERtrim® (SMT RF Tuning)

Mechanical Characteristics

Size	EIA 0603		EIA 0805		EIA 1210	
	inches	(mm)	inches	(mm)	inches	(mm)
L	.058 ± .008	(1.47 ± .20)	.080 ± .008	(2.00 ± .20)	.130 ± .008	(3.30 ± .20)
W	.032 ± .008	(0.81 ± .20)	.050 ± .008	(1.27 ± .20)	.100 ± .008	(2.54 ± .20)
T	.025 MAX	(0.64 MAX)	.025 ± .005	(0.64 ± .13)	.025 ± .005	(0.64 ± .13)
x & y	.004 MIN	(0.10 MIN)	.004 MIN	(0.10 MIN)	.004 MIN	(0.10 MIN)
E/B	.005 MAX	(0.13 MAX)	.005 MIN	(0.13 MIN)	.005 MIN	(0.13 MIN)
E/B*	.012 MAX	(0.30 MAX)	N/A (0603 Only)		N/A (0603 Only)	

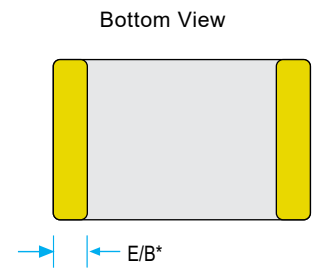
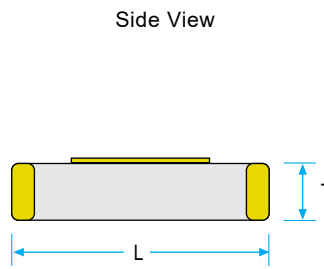
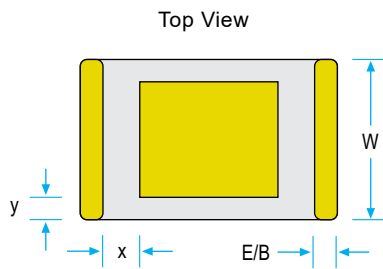

Electrical Characteristics

Working Voltage	50 Volts DC
Temperature Coefficient	0 ± 30ppm /°C, -55 to 125°C
Dissipation Factor	.001 (0.1%) max, 25°C
Insulation Resistance	> 10 GΩ @ 25°C, WVDC; 125°C IR is 10% of 25°C rating.
Dielectric Strength	2.5 X WVDC, 25°C, 50mA max
Test Parameters	1 MHz ± 50kHz, 1.0 ± 0.2 VRMS, 25°C

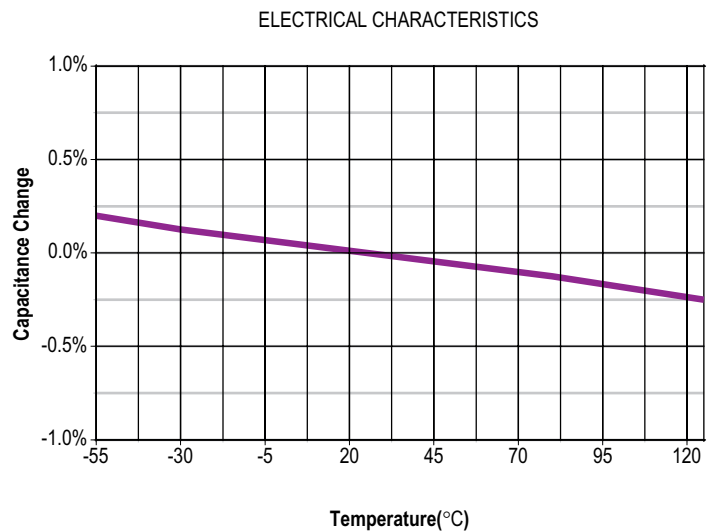

Environmental Meets the environmental characteristics outlined for Johanson S-Series capacitors (refer to the second page of the S-Series specification sheet). Terminal adhesion for all sizes exceeds 2.0 lbs.



RF Capacitors
LASERtrim® (SMT RF Tuning)

RF Characteristics - Model Selection

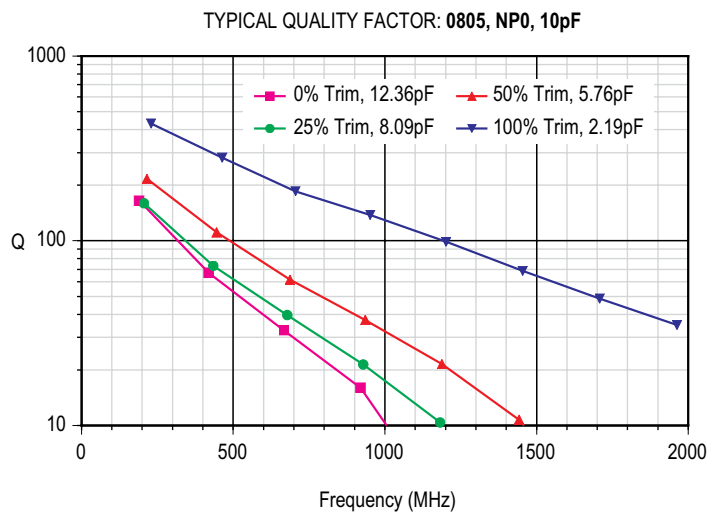
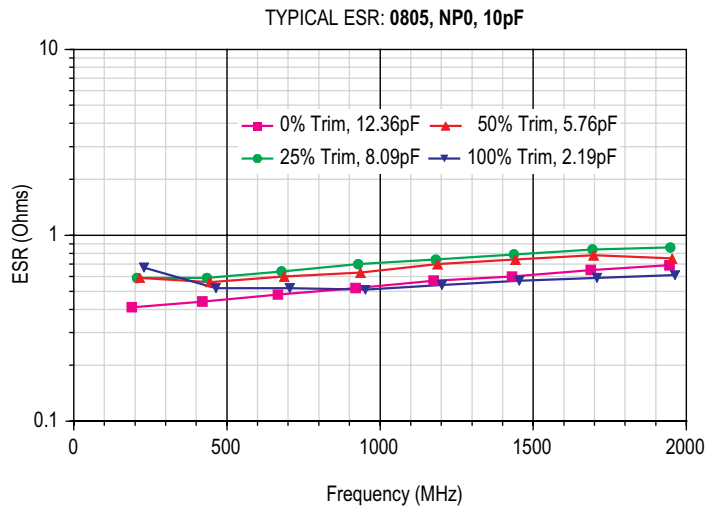

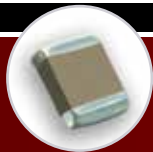

Capacitors
TANCERAM®

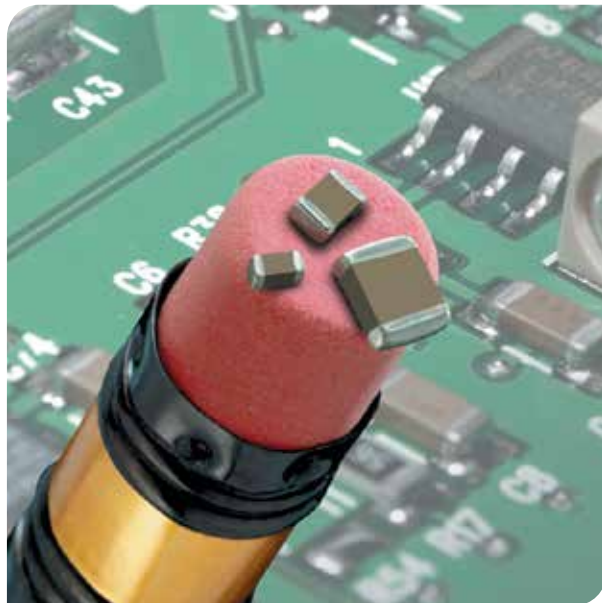

Features:

- Low ESR
- Low DC Leakage
- Reduced Chip Size
- Improved Reliability
- Higher Surge Voltage
- Non-Polarized Devices
- Higher Ripple Current
- Higher Insulation Resistance

Common Applications:

- Back-lighting Inverters
- General Digital Circuits
- DC/DC Converter Smoothing (Input/Output)
- Switching Power Supply Smoothing (Input/Output)

Typical ESR Comparison

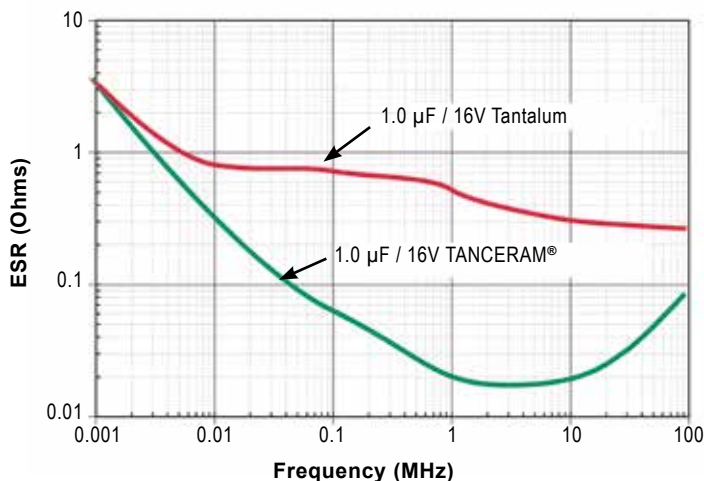

Typical Breakdown Voltage Comparison

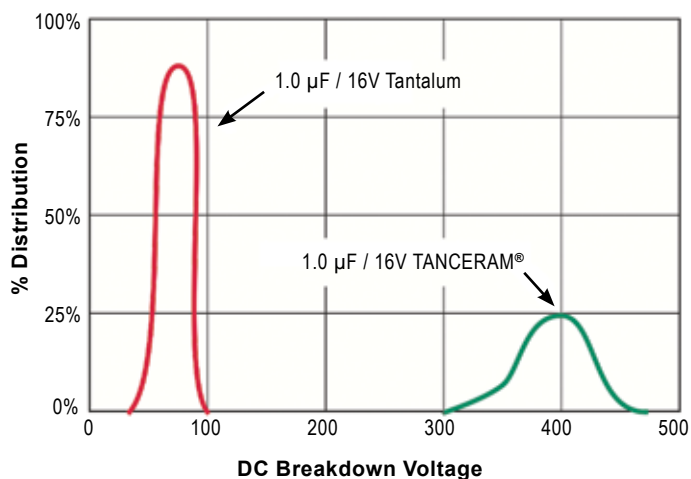

HOW TO ORDER

TC	CT	500	W	105	K	1	GV	001	E
Subfamily	Size	Voltage	DTC	Capacitance	Tol	Mark	Termination	Special Code	Pack
TC = Tanceram® Hi-Cap	See chart	6R3 = 6.3 V 100 = 10 V 160 = 16 V 250 = 25 V 500 = 50 V 101 = 100 V	G = NP0/COG W = X7R	1st two digits are significant; 3rd digit denotes number of zeros. 105 = 1.00 µF 476 = 47.0 µF 107 = 100 µ	K = ±10% M = ±20%	1 = No mark	GV = Ni/Sn (RoHS) NT = Ni/SnPb *avail on selected parts	001 = Default catalog item	E = 7" Reel Emb Tape T = 7" Reel Paper Tape

Example: TCCT500W105K1GV001E Capacitors Tanceram, Hi-Cap, 0805, X7R, 50.0V, 1.000µF±10%, Ni/Sn (RoHS), 7" Reel Embossed Tape



Capacitors
TANCERAM® Selection Guide

Selection & Electrical

Characteristics

EIA		Inches	(mm)	VDC	1.0 µF		1.5 µF		2.2 µF		3.3 µF		4.7 µF		10 µF		22 µF		47 µF	100 µF	220 µF
				Dielectric	W	X	W	X	W	X	W	X	W	X	W	X	W	X	X	X	
0201	L	.024 ±.001	(0.60 ±.03)	50																	
	W	.011 ±.001	(0.28 ±.03)	10																	
	T	.013 Max.	(0.33 Max.)	6.3																	
	EB	.004 Min.	(0.10 Min.)	4																	
0402	L	.039 ±.002	(0.99 ±.05)	35																	
	W	.020 ±.002	(0.51 ±.05)	25																	
	T	.022 Max.	(0.55 Max.)	16																	
	EB	.002 Min.	(0.05 Min.)	6.3																	
0603	L	.063 ±.004	(1.60 ±.10)	50																	
	W	.031 ±.004	(0.79 ±.10)	35																	
	T	.037 Max.	(0.93 Max.)	25																	
	EB	.006 Min.	(0.15 Min.)	16																	
0805	L	.079 ±.012	(2.01 ±.30)	50																	
	W	.049 ±.008	(1.24 ±.20)	35																	
	T	.057 Max.	(1.44 Max.)	25																	
	EB	.008 Min.	(0.20 Min.)	16																	
1206	L	.126 ±.012	(3.20 ±.30)	50																	
	W	.063 ±.008	(1.60 ±.20)	35																	
	T	.071 Max.	(1.80)	25																	
	EB	.010 Min.	(0.25 Min.)	16																	
1210	L	.126 ±.012	(3.20 ±.30)	50																	
	W	.098 ±.012	(2.49 ±.30)	35																	
	T	.106 Max.	(2.69 Max.)	25																	
	EB	.012 Min.	(0.30 Min.)	16																	
1812	L	.177 ±.016	(4.50 ±.41)	50																	
	W	.126 ±.012	(3.20 ±.30)	35																	
	T	.118 Max.	(2.99 Max.)	25																	
	EB	.012 Min.	(0.30 Min.)	16																	
2220	L	.220 ±.016	(5.59 ±.41)	50																	
	W	.197 ±.016	(3.20 ±.30)	35																	
	T	.118 Max.	(2.99 Max.)	25																	
	EB	.012 Min.	(0.30 Min.)	16																	

"K" or "M" Tolerance, 0201 Only Available in M

only "m" tolerance

Electrical Characteristics

DIELECTRIC:	X7R	X5R
Temperature Coefficient:	±15% (-55 to +125°C)	±15% (-55 to +85°C)
Dissipation Factor:	For ≥ 50 VDC: 7.5% max.	For ≥ 50 VDC: 7.5% max.
	For ≤ 35 VDC: 10% max.	For ≤ 35 VDC: 10% max.
Insulation Resistance (Min. @ 25°C, WVDC)	100 ΩF or 10 GΩ, whichever is less	
Dielectric Strength:	2.5 X WVDC, 25°C, 50mA max.	
Test Conditions:	Capacitance values ≤ 10 µF: 1.0kHz ± 50Hz @ 1.0 ± 0.2 Vrms Capacitance values > 10 µF: 120Hz ± 10Hz @ 0.5V ± 0.1 Vrms	
Other	See page 81 for additional dielectric specifications.	

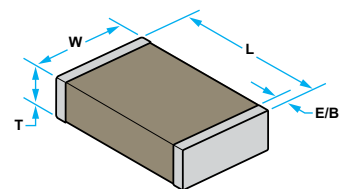

DIELECTRIC:
W (X7R) X (X5R)



RF Capacitors
Single Layer (SLC)

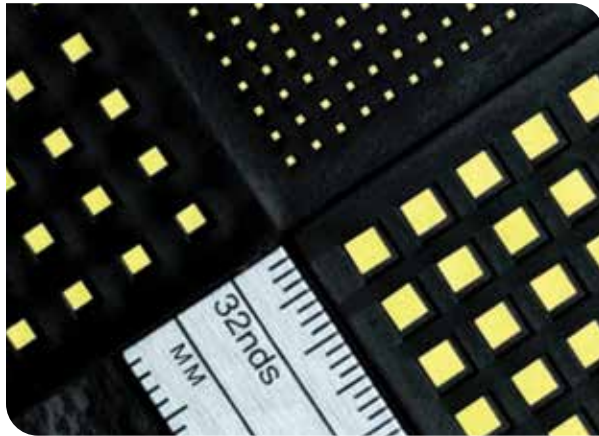

Johanson Single Layer Capacitors (SLCs) are offered in a wide range of dielectrics for very high frequency applications.

Available in sizes from 0.25mm x 0.25mm (10mil x 10mil) to 2.28mm x 2.28mm (90mil x 90mil), these single layer capacitors are used in military infrastructure and industrial markets.

In addition to their excellent performance, reliability and consistency in volume production has been the focus.

Border Type Selection

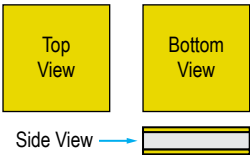
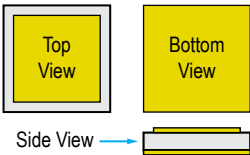
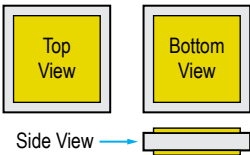
Series	Type	Configurations
S0	No Border	
S1	Single Border	
S2	Dual Border	

Features:

- Ceramic, low profile services exhibit very high-Q / low insertion loss; SRFs to 50 GHz
- Thin film gold electrodes provide superior wire bonding & die attach performance
- Four Single Layer (SLC) Device Types to Fit Many Applications:
 - Standard Single Layer
 - Border Single Layer
 - Bar Single Layer Arrays
 - Custom Single Layer Products

Common Applications:

- Microwave Integrated Components
- GaAs Integrated Circuits
- RF/Microwave Components
- DC Block, Bypass, Tuning



Metallization Characteristics

Metallization Type	TiW/Au (Titanium-Tungsten/Gold)	TiW/Ni/Au (Titanium-Tungsten/Nickel/Gold)	TiW/Pt/Au (Titanium-Tungsten/Platinum/Gold)
Termination Code	S2	S1	S0
Attachment Compatibility Wire / Ribbon Bonding	Wire / Ribbon Bonding Silver or Gold Conductive Epoxy Au/Ge or Au/Si Eutectic Preform Excellent High Temperature Resistance (400°C) Unsuitable for Pb/Sn or Au/Sn Soldering	Pb/Sn or Au/Sn Soldering Au/Sn Eutectic Preform Moderate High Temp. Resistance (325°C) Long term high temperature may cause Ni diffusion and wire bond problems on Au/Ge	Pb/Sn or Au/Sn Soldering Au/Sn Eutectic Preform Moderate High Temp. Resistance (325°C) Long term high temperature may cause Ni diffusion and wire bond problems on Au/Ge

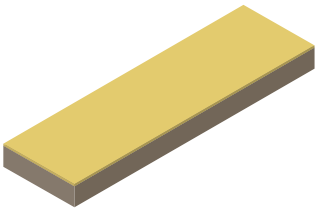
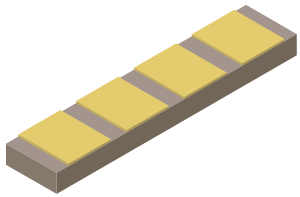
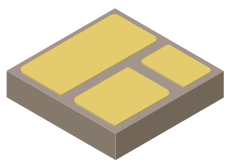
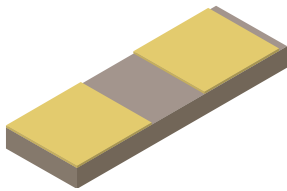

RF Capacitors
Single Layer (SLC)

Options Available (SLC)

Rectangular	
Bar Cap Arrays	
Binary	
Dual Split	
Mounting Short	

Environmental Characteristics (SLC)

Bond Strength	Exceeds MIL-S-883, Meth. 2011
Shear Strength	Exceeds MIL-S-883, Meth. 2019
Solder Heat Resistance	MIL-S-202, Meth. 210-C, (260±5°C, 5 sec.)
Solderability	MIL-S-202, Meth. 208, (245±5°C, 5 sec.)
Shock	MIL-S-202, Meth. 213-I, (100g, 6 msec.)
Thermal Shock	MIL-S-202, Meth. 107, A, (-55 to +125°C)
Vibration	MIL-S-202, Meth. 204-G, (30g, 10-2000Hz)
Burn-In Life Test	MIL-S-202, Meth. 108, A/F
Low Voltage Humidity	Mil-C-49464, Para. 3.17
Barometric Pressure	MIL-S-202, Meth. 105, B
Immersion Salt Spray	MIL-S-202, Meth. 104, B
Moisture Resistance	MIL-S-202, Meth. 106



RF Capacitors Single Layer (SLC)

Options & Environmental

Characteristics

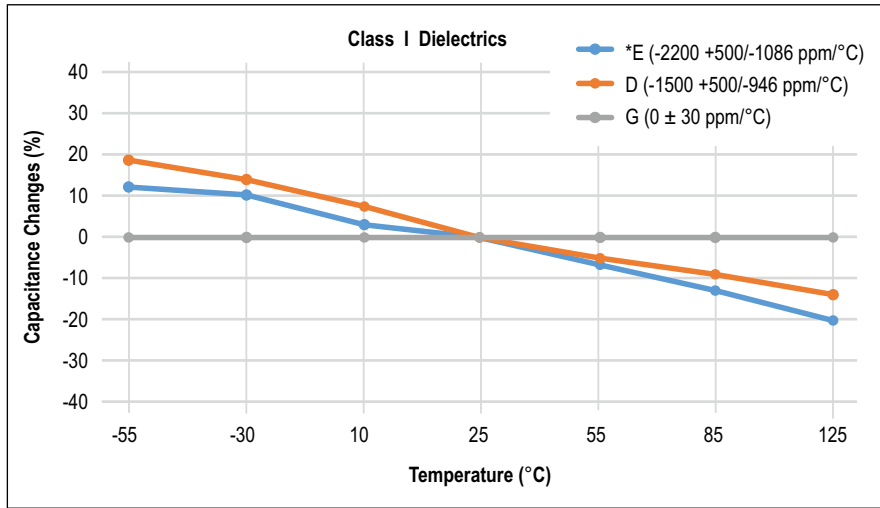

Note: *Capacitance change is lower than 18% at from -55 to 25°C range

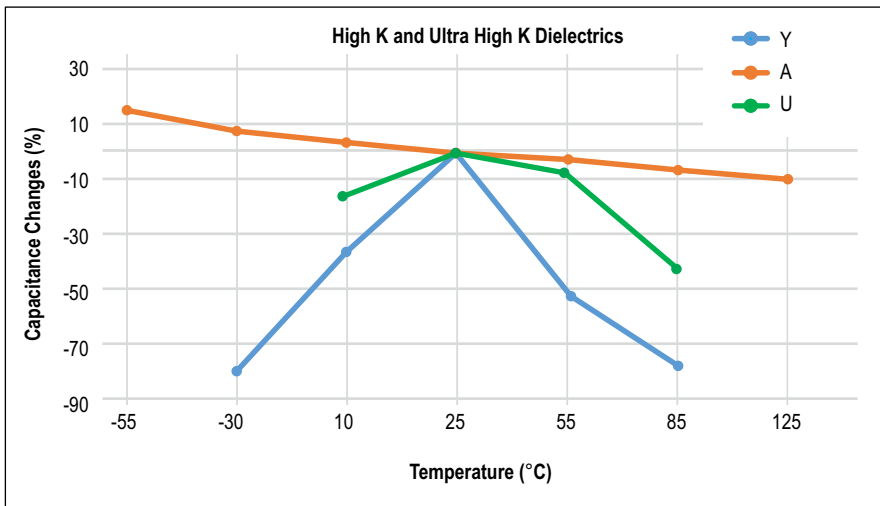
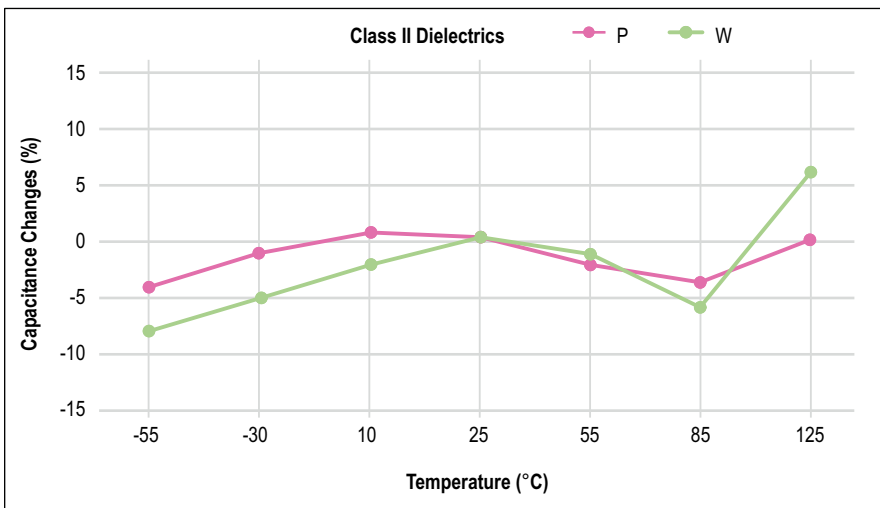



RF Capacitors
Single Layer (SLC)

Dielectric Characteristics - RF Single Layer Capacitors (SLC)

Dielectric Code	Constant (K)	Temperature Coefficient	Temperature Range	Dissipation Factor (DF)	Test Conditions	Tolerances
G	23 - 76	0 ± 30ppm	-55°C to +125°C	≤ 0.15% @ 1MHz	1	B, C, D (A, <2pF) (F-K, >10pF)
D	160	-1,500 +500ppm / -946ppm	-55°C to +125°C	≤ 0.25% @ 1MHz	1	J, K, M (B, C, D <10pF)
E	440	-2,200 +500ppm / -1,086ppm	-55°C to +125°C	≤ 1.5% @ 1MHz	1	J, K, M (C, D <10pF)
P	725 - 1,410	± 10%	-55°C to +125°C	≤ 2.50% @ 1kHz	2	J, K, M
W	2,300 - 4,100	± 15%	-55°C to +125°C	≤ 2.50% @ 1kHz	2	J, K, M
U	8,500	+22% - 56%	+10°C to +85°C	≤ 4.00% @ 1kHz	2	M, X
Y	15,000	+22% - 82%	-30°C to +85°C	≤ 4.00% @ 1kHz	2	M, X
A	15,000 - 65,000	± 15%	-55°C to +125°C	≤ 2.50% @ 1kHz	2	K, M, X

Note: Colors indicate a specific material.

Per MIL-PRF-49464C - 3.8 Dissipation factor. When determined as specified in 4.8.5, the dissipation factor for capacitors of 4.7 pF or greater shall not exceed: 0.15% for G – Dielectric, 2.5% for P – Dielectric. Customer Specification takes preference if referenced on the Purchase Order.

Electrical Characteristics

Voltage Rating	16; 25; 50; & 100 WVDC
Dielectric Strength	2.5 x WVDC min, 25°C, 50 mA max
Test Conditions	Class 1 1.0 ± 0.2 VRMS @ 1MHz, 25°C Class 2 For values ≤ 100pF: 1.0±0.2 VRMS @ 1MHz, 25°C; for ALL other Values: 1.0±0.2 VRMS @1KHz,25°C Class 3 1.0±0.2 VRMS @ 1KHz



RF Capacitors

Single Layer (SLC) - No Border

S0
SERIES

GPN = Global Part Number
S0 = No Border

S0 Series Configuration

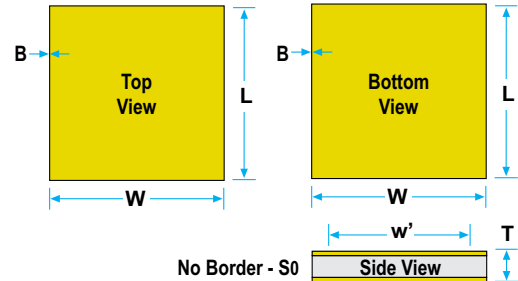

S0 Series Mechanical Characteristics:

GPN Code	Size	Width (W)	Max Length (L)	Border (B)	Thickness (T)	Thickness for A-Dielectric
S0AA	inch	0.010" + 0.001"/-0.003"	0.012"	No Border	0.006" ± 0.0025" 0.153mm ± 0.064mm	0.007" ± 0.002" 0.177mm ± 0.051mm
	mm	0.254mm + 0.025mm/-0.076mm	0.305mm			
S0AG	inch	0.012" + 0.001"/-0.003"	0.015"			
	mm	0.305mm + 0.025mm/-0.076mm	0.381mm			
S0AL	inch	0.015" + 0.001"/-0.003"	0.020"			
	mm	0.381mm + 0.025mm/-0.076mm	0.508mm			
S0AP	inch	0.020" + 0.001"/-0.003"	0.025"			
	mm	0.508mm + 0.025mm/-0.076mm	0.635mm			
S0AU	inch	0.025" + 0.001"/-0.003"	0.030"			
	mm	0.635mm + 0.025mm/-0.076mm	0.762mm			
S0BC	inch	0.030" + 0.001"/-0.003"	0.035"			
	mm	0.762mm + 0.025mm/-0.076mm	0.889mm			
S0BG	inch	0.035" ± 0.005"	0.040"			
	mm	0.889mm ± 0.127mm	1.016mm			
S0BL	inch	0.040" ± 0.005"	0.045"			
	mm	1.016mm ± 0.127mm	1.143mm			
S0BQ	inch	0.050" ± 0.010"	0.060"			
	mm	1.270mm ± 0.254mm	1.524mm			
S0BR	inch	0.070" ± 0.010"	0.080"			
	mm	1.778mm ± 0.254mm	2.032mm			
S0BT	inch	0.090" ± 0.010"	0.100"			
	mm	2.286mm ± 0.254mm	2.450mm			



RF Capacitors

Single Layer (SLC) - No Border

S0
SERIES

No Border (S0 Series) Capacitance Selection:

GPN Code		S0AA				S0AG				S0AL				S0AP				S0AU				
Part Size		0.010" x 0.010"				0.012" x 0.012"				0.015" x 0.015"				0.020" x 0.020"				0.025" x 0.025"				
pF	Code	16V	25V	50V	100V	16V	25V	50V	100V	16V	25V	50V	100V	16V	25V	50V	100V	16V	25V	50V	100V	
0.1	0R1			G	G			G	G													
0.2	0R2			G	G			G	G			G	G									
0.3	0R3			G	G			G	G			G	G			G	G					
0.4	0R4			G	G			G	G			G	G			G	G			G	G	
0.5	0R5			D	D			G	G			G	G			G	G			G	G	
0.6	0R6			D	D			G	G			G	G			G	G			G	G	
0.7	0R7			D	D			D	D			G	G			G	G			G	G	
0.8	0R8			D	D			D	D			G	G			G	G			G	G	
0.9	0R9			D	D			D	D			G	G			G	G			G	G	
1.0	1R0			D	D			D	D			G	G			G	G			G	G	
1.1	1R1			E	E			D	D			D	D			G	G			G	G	
1.2	1R2			E	E			D	D			D	D			G	G			G	G	
1.3	1R3			E	E			D	D			D	D			G	G			G	G	
1.4	1R4			E	E			D	D			D	D			G	G			G	G	
1.5	1R5			E	E			D	D			D	D			G	G			G	G	
1.6	1R6			E	E			E	E			D	D			G	G			G	G	
1.7	1R7			E	E			E	E			D	D			G	G			G	G	
1.8	1R8			E	E			E	E			D	D			G	G			G	G	
1.9	1R9			E	E			E	E			D	D			D	D			G	G	
2.0	2R0			E	E			E	E			D	D			D	D			G	G	
2.1	2R1			E	E			E	E			D	D			D	D			G	G	
2.2	2R2			E	E			E	E			D	D			D	D			G	G	
2.4	2R4			P	P			E	E			D	D			D	D			G	G	
2.7	2R7			P	P			E	E			E	E			D	D			G	G	
3.0	3R0			P	P			E	E			E	E			D	D			D	D	
3.3	3R3			P	P			P	P			E	E			D	D			D	D	
3.6	3R6			P	P			P	P			E	E			D	D			D	D	
3.9	3R9			P	P			P	P			E	E			D	D			D	D	
4.3	4R3			P	P			P	P			E	E			D	D			D	D	
4.7	4R7			P	P			P	P			E	E			E	E			D	D	
5.1	5R1			P	P			P	P			P	P			E	E			D	D	
5.6	5R6			P	P			P	P			P	P			E	E			D	D	
6.2	6R2			P	P			P	P			P	P			E	E			D	D	
6.8	6R8			P	P			P	P			P	P			E	E			E	E	
7.5	7R5			W	W			P	P			P	P			E	E			E	E	
8.2	8R2			W	W			P	P			P	P			E	E			E	E	
9.1	9R1			W	W			P	P			P	P			P	P			E	E	
10	100			W	W			W	W			P	P			P	P			E	E	
12	120			W	W			W	W			P	P			P	P			E	E	
15	150			W	W			W	W			P	P			P	P			P	P	
18	180			W	W			W	W			W	W			P	P			P	P	
20	200			W	W			W	W			W	W			P	P			P	P	
22	220			U	U			W	W			W	W			P	P			P	P	
27	270			U	U			W	W			W	W			W	W			P	P	
33	330			U	U			U	U			W	W			W	W			P	P	
39	390			U	U			U	U			W	W			W	W			P	P	
47	470			Y	Y			U	U			W	W			W	W			W	W	
50	500			Y	Y			U	U			U	U			W	W			W	W	
51	510			Y	Y			U	U			U	U			W	W			W	W	
56	560	A	A	Y	Y	A	A	A	U	A	A	A	U	A	A	A	W			W	W	
68	680	A	A	Y	Y	A	A	A	Y	A	A	A	U	A	A	A	W			W	W	
75	750	A	A	Y	Y	A	A	Y	Y	A	A	A	U	A	A	A	A			W	W	
82	820	A	A			A	A	Y	Y	A	A	A	U	A	A	A	W	A	A	A	W	



RF Capacitors

Single Layer (SLC) - No Border

S0 SERIES

No Border (S0 Series) Capacitance Selection:

GPN Code		S0AA				S0AG				S0AL				S0AP				S0AU			
Part Size		0.010" x 0.010"				0.012" x 0.012"				0.015" x 0.015"				0.020" x 0.020"				0.025" x 0.025"			
pF	Code	16V	25V	50V	100V	16V	25V	50V	100V	16V	25V	50V	100V	16V	25V	50V	100V	16V	25V	50V	100V
100	101	A	A			A	A	Y	Y	A	A	A	Y	A	A	A	U	A	A	A	W
120	121	A				A	A			A	A	Y	Y	A	A	A	U	A	A	A	W
150	151	A				A				A	A	Y	Y	A	A	A	U	A	A	A	U
180	181	A				A				A	A	Y		A	A	A	Y	A	A	A	U
200	201					A				A	A			A	A	A	Y	A	A	A	U
220	221					A				A	A			A	A	Y	Y	A	A	A	U
270	271									A				A	A	Y	Y	A	A	A	Y
330	331									A				A	A			A	A	Y	Y
390	391									A				A	A			A	A	Y	Y
470	471													A				A	A	Y	Y
560	561													A				A	A		
680	681													A				A			
750	751													A				A			
820	821																	A			
1,000	102																	A			
1,200	122																				
1,500	152																				
1,800	182																				
2,000	202																				
2,200	222																				
2,500	252																				
2,700	272																				
3,300	332																				
3,900	392																				
4,700	472																				
5,600	562																				
6,200	622																				
6,800	682																				
7,500	752																				
8,200	822																				
10,000	103																				

Note: Color breaks used to highlight changes in dielectric material, letters indicate the specific material. Contact factory for higher capacitance values.



RF Capacitors

Single Layer (SLC) - No Border

S0
SERIES

No Border (S0 Series) Capacitance Selection:

GPN Code		S0BC				S0BG				S0BL				S0BQ				S0BR				S0BT			
Part Size		0.030" x 0.030"				0.035" x 0.035"				0.040: x 0.040"				0.050: x 0.050"				0.070" x 0.070"				0.090" x 0.090"			
pF	Code	16V	25V	50V	100V	16V	25V	50V	100V	16V	25V	50V	100V	16V	25V	50V	100V	16V	25V	50V	100V	16V	25V	50V	100V
0.1	0R1																								
0.2	0R2																								
0.3	0R3																								
0.4	0R4																								
0.5	0R5																								
0.6	0R6			G	G																				
0.7	0R7			G	G																				
0.8	0R8			G	G			G	G																
0.9	0R9			G	G			G	G																
1.0	1R0			G	G			G	G			G	G												
1.1	1R1			G	G			G	G			G	G												
1.2	1R2			G	G			G	G			G	G												
1.3	1R3			G	G			G	G			G	G												
1.4	1R4			G	G			G	G			G	G												
1.5	1R5			G	G			G	G			G	G												
1.6	1R6			G	G			G	G			G	G			G	G								
1.7	1R7			G	G			G	G			G	G			G	G								
1.8	1R8			G	G			G	G			G	G			G	G								
1.9	1R9			G	G			G	G			G	G			G	G								
2.0	2R0			G	G			G	G			G	G			G	G								
2.1	2R1			G	G			G	G			G	G			G	G								
2.2	2R2			G	G			G	G			G	G			G	G								
2.4	2R4			G	G			G	G			G	G			G	G								
2.7	2R7			G	G			G	G			G	G			G	G								
3.0	3R0			G	G			G	G			G	G			G	G			G	G				
3.3	3R3			G	G			G	G			G	G			G	G			G	G				
3.6	3R6			G	G			G	G			G	G			G	G			G	G				
3.9	3R9			G	G			G	G			G	G			G	G			G	G				
4.3	4R3			D	D			G	G			G	G			G	G			G	G				
4.7	4R7			D	D			G	G			G	G			G	G			G	G				
5.1	5R1			D	D			G	G			G	G			G	G			G	G			G	G
5.6	5R6			D	D			G	D			G	G			G	G			G	G			G	G
6.2	6R2			D	D			D	D			G	G			G	G			G	G			G	G
6.8	6R8			D	D			D	D			G	G			G	G			G	G			G	G
7.5	7R5			D	D			D	D			D	D			G	G			G	G			G	G
8.2	8R2			D	D			D	D			D	D			G	G			G	G			G	G
9.1	9R1			D	D			D	D			D	D			G	G			G	G			G	G
10	100			E	E			D	D			D	D			G	G			G	G			G	G
12	120			E	E			D	D			D	D			D	D			G	G			G	G
15	150			E	E			E	E			D	D			D	D			G	G			G	G
18	180			E	E			E	E			E	E			D	D			G	G			G	G
20	200			E	E			E	E			E	E			D	D			G	G			G	G
22	220			E	E			E	E			E	E			D	D			D	D			G	G
27	270			P	P			E	E			E	E			E	E			D	D			G	G
33	330			P	P			P	P			E	E			E	E			D	D			G	G
39	390			P	P			P	P			P	P			E	E			D	D			D	D
47	470			P	P			P	P			P	P			E	E			D	D			D	D
50	500			P	P			P	P			P	P			E	E			D	D			D	D
51	510			P	P			P	P			P	P			E	E			D	D			D	D



RF Capacitors

Single Layer (SLC) - No Border

S0
SERIES

No Border (S0 Series) Capacitance Selection:

GPN Code		S0BC				S0BG				S0BL				S0BQ				S0BR				S0BT			
Part Size		0.030" x 0.030"				0.035" x 0.035"				0.040: x 0.040"				0.050: x 0.050"				0.070" x 0.070"				0.090" x 0.090"			
pF	Code	16V	25V	50V	100V	16V	25V	50V	100V	16V	25V	50V	100V	16V	25V	50V	100V	16V	25V	50V	100V	16V	25V	50V	100V
56	560			W	W			P	P			P	P			E	E			E	E			D	D
68	680			W	W			P	P			P	P			P	P			E	E			D	D
75	750			W	W			P	P			P	P			P	P			E	E			D	D
82	820			W	W			W	W			P	P			P	P			E	E			D	D
100	101			W	W			W	W			P	P			P	P			E	E			E	E
120	121	A	A	A	W			W	W			W	W			P	P			P	P			E	E
150	151	A	A	A	W			W	W			W	W			P	P			P	P			E	E
180	181	A	A	A	W	A	A	A	W			W	W			W	W			P	P			P	P
200	201	A	A	A	U	A	A	A	W			W	W			W	W			P	P			P	P
220	221	A	A	A	U	A	A	A	W	A	A	A	W			W	W			P	P			P	P
270	271	A	A	A	U	A	A	A	U	A	A	A	W			W	W			P	P			P	P
330	331	A	A	A	U	A	A	A	U	A	A	A	W	A	A	A	W			W	W			P	P
390	391	A	A	A	Y	A	A	A	U	A	A	A	U	A	A	A	W			W	W			P	P
470	471	A	A	Y	Y	A	A	A	U	A	A	A	U	A	A	A	W			W	W			P	P
560	561	A	A	Y	Y	A	A	A	Y	A	A	A	U	A	A	A	U			W	W			W	W
680	681	A	A	Y	Y	A	A	Y	Y	A	A	A	Y	A	A	A	U	A	A	A	W			W	W
750	751	A	A			A	A	Y	Y	A	A	A	Y	A	A	A	U	A	A	A	W			W	W
820	821	A	A			A	A	Y	Y	A	A	Y	Y	A	A	A	U	A	A	A	W			W	W
1,000	102	A				A	A			A	A	Y	Y	A	A	A	Y	A	A	A	W			W	W
1,200	122	A				A	A			A	A	Y	Y	A	A	A	Y	A	A	A	U			W	W
1,500	152	A				A				A	A			A	A	Y	Y	A	A	A	U	A	A	A	W
1,800	182					A				A				A	A	Y	Y	A	A	A	U	A	A	A	U
2,000	202					A				A				A	A			A	A	A	Y	A	A	A	U
2,200	222					A				A				A	A			A	A	A	Y	A	A	A	U
2,500	252									A				A				A	A	Y	Y	A	A	A	U
2,700	272									A				A				A	A	Y	Y	A	A	A	U
3,300	332													A				A	A	Y	Y	A	A	A	Y
3,900	392													A				A	A			A	A	A	Y
4,700	472													A				A	A			A	A	Y	Y
5,600	562																	A				A	A	Y	Y
6,200	622																	A				A	A		
6,800	682																	A				A	A		
7,500	752																	A				A	A		
8,200	822																	A				A			
10,000	103																					A			

Note: Color breaks used to highlight changes in dielectric material, letters indicate the specific material. Contact factory for higher capacitance values.



RF Capacitors

Single Layer (SLC) - Single Border

S1
SERIES

GPN = Global Part Number
S1 = Single Border

S1 Series Configuration

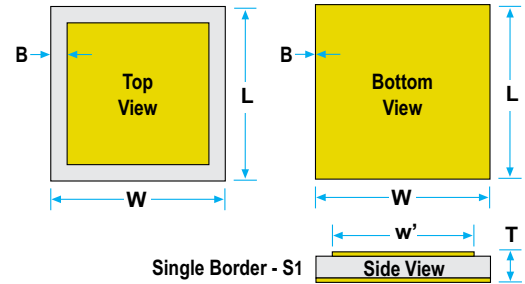

S1 Series Mechanical Characteristics:

GPN Code	Size	Width (W) & Length (L)	Border (B)	Thickness (T)	Thickness for A-Dielectric	
S1AA	inch	0.010" ± 0.001"	0.001" (0.0005" min.)	0.006" ± 0.0025" 0.153mm ± 0.064mm	0.007" ± 0.002" 0.177mm ± 0.051mm	
	mm	0.254mm ± 0.025mm	0.025mm, (0.013mm min.)			
S1AG	inch	0.012" ± 0.001"	0.001" (0.0005" min.)			
	mm	0.305mm ± 0.025mm	0.025mm, (0.013mm min.)			
S1AL	inch	0.015" ± 0.001"	0.002" ± 0.001" 0.051mm ± 0.025mm			
	mm	0.381mm ± 0.025mm				
S1AP	inch	0.020" ± 0.001"				
	mm	0.508mm ± 0.025mm				
S1AU	inch	0.025" ± 0.001"				
	mm	0.635mm ± 0.025mm				
S1BC	inch	0.030" ± 0.001"				0.003" ± 0.001" 0.076mm ± 0.025mm
	mm	0.762mm ± 0.025mm				
S1BG	inch	0.035" ± 0.001"				
	mm	0.889mm ± 0.025mm				
S1BL	inch	0.040" ± 0.001"				
	mm	1.016mm ± 0.025mm				
S1BQ	inch	0.050" ± 0.05"				
	mm	1.270mm ± 0.127mm				
S1BR	inch	0.070" ± 0.05"				
	mm	1.778mm ± 0.127mm				
S1BT	inch	0.090" ± 0.05"				
	mm	2.286mm ± 0.127mm				



RF Capacitors

Single Layer (SLC) - Single Border

S1
SERIES

Recessed SLC electrode borders help prevent shorting from conductive epoxy squeeze-up and aid visual recognition equipment. The V-Series SLCs feature dual borders (top & bottom) while the B-Series SLCs feature a single border (top-only).

Single Border (S1 Series) Capacitance Selection:

GPN Code		S1AA				S1AG				S1AL				S1AP				S1AU				
Part Size		0.010" x 0.010"				0.012" x 0.012"				0.015" x 0.015"				0.020" x 0.020"				0.025" x 0.025"				
pF	Code	16V	25V	50V	100V	16V	25V	50V	100V	16V	25V	50V	100V	16V	25V	50V	100V	16V	25V	50V	100V	
0.1	0R1			G	G			G	G													
0.2	0R2			G	G			G	G			G	G									
0.3	0R3			G	G			G	G			G	G			G	G					
0.4	0R4			G	D			G	G			G	G			G	G			G	G	
0.5	0R5			D	D			G	G			G	G			G	G			G	G	
0.6	0R6			D	D			D	D			G	G			G	G			G	G	
0.7	0R7			D	D			D	D			G	G			G	G			G	G	
0.8	0R8			D	D			D	D			G	G			G	G			G	G	
0.9	0R9			D	D			D	D			D	D			G	G			G	G	
1.0	1R0			E	E			D	D			D	D			G	G			G	G	
1.1	1R1			E	E			D	D			D	D			G	G			G	G	
1.2	1R2			E	E			D	D			D	D			G	G			G	G	
1.3	1R3			E	E			D	D			D	D			G	G			G	G	
1.4	1R4			E	E			E	E			D	D			G	G			G	G	
1.5	1R5			E	E			E	E			D	D			G	G			G	G	
1.6	1R6			E	E			E	E			D	D			G	G			G	G	
1.7	1R7			E	E			E	E			D	D			D	D			G	G	
1.8	1R8			E	E			E	E			D	D			D	D			G	G	
1.9	1R9			E	E			E	E			D	D			D	D			G	G	
2.0	2R0			E	E			E	E			D	D			D	D			G	G	
2.1	2R1			P	P			E	E			D	D			D	D			G	G	
2.2	2R2			P	P			E	E			E	E			D	D			G	G	
2.4	2R4			P	P			E	E			E	E			D	D			G	G	
2.7	2R7			P	P			E	E			E	E			D	D			D	D	
3.0	3R0			P	P			E	E			E	E			D	D			D	D	
3.3	3R3			P	P			P	P			E	E			D	D			D	D	
3.6	3R6			P	P			P	P			E	E			D	D			D	D	
3.9	3R9			P	P			P	P			E	E			D	D			D	D	
4.3	4R3			P	P			P	P			P	P			E	E			D	D	
4.7	4R7			P	P			P	P			P	P			E	E			D	D	
5.1	5R1			P	P			P	P			P	P			E	E			D	D	
5.6	5R6			P	P			P	P			P	P			E	E			D	D	
6.2	6R2			W	W			P	P			P	P			E	E			D	D	
6.8	6R8			W	W			P	P			P	P			E	E			E	E	
7.5	7R5			W	W			P	P			P	P			E	E			E	E	
8.2	8R2			W	W			P	P			P	P			P	P			E	E	
9.1	9R1			W	W			W	W			P	P			P	P			E	E	
10	100			W	W			W	W			P	P			P	P			E	E	
12	120			W	W			W	W			P	P			P	P			E	E	
15	150			W	W			W	W			W	W			P	P			P	P	
18	180			W	W			W	W			W	W			P	P			P	P	
20	200			U	U			W	W			W	W			P	P			P	P	
22	220			U	U			W	W			W	W			P	P			P	P	
27	270			U	U			W	W			W	W			W	W			P	P	
33	330			U	U			U	U			W	W			W	W			P	P	



RF Capacitors

Single Layer (SLC) - Single Border

S1
SERIES

Single Border (S1 Series) Capacitance Selection:

GPN Code		S1AA				S1AG				S1AL				S1AP				S1AU			
Part Size		0.010" x 0.010"				0.012" x 0.012"				0.015" x 0.015"				0.020" x 0.020"				0.025" x 0.025"			
pF	Code	16V	25V	50V	100V	16V	25V	50V	100V	16V	25V	50V	100V	16V	25V	50V	100V	16V	25V	50V	100V
39	390			Y	Y			U	U			W	W			W	W			W	W
47	470			Y	Y			U	U			U	U			W	W			W	W
50	500			Y	Y			U	Y			U	U			W	W			W	W
51	510			Y	Y			Y	Y			U	U			W	W			W	W
56	560	A	A	Y	Y	A	A	Y	Y	A	A	A	U	A	A	A	W			W	W
68	680	A	A			A	A	Y	Y	A	A	A	U	A	A	A	W			W	W
75	750	A	A			A	A	Y	Y	A	A	A	U	A	A	A	W			W	W
82	820	A	A			A	A	Y	Y	A	A	A	Y	A	A	A	U	A	A	A	W
100	101	A				A	A			A	A	Y	Y	A	A	A	U	A	A	A	W
120	121	A				A	A			A	A	Y	Y	A	A	A	U	A	A	A	W
150	151	A				A				A	A			A	A	A	Y	A	A	A	U
180	181					A				A	A			A	A	A	Y	A	A	A	U
200	201					A				A				A	A	Y	Y	A	A	A	U
220	221					A				A				A	A	Y	Y	A	A	A	U
270	271									A				A	A	Y	Y	A	A	A	Y
330	331									A				A	A			A	A	Y	Y
390	391													A				A	A	Y	Y
470	471													A				A	A		
560	561													A				A	A		
680	681													A				A			
750	751																	A			
820	821																	A			
1,000	102																	A			
1,200	122																				
1,500	152																				
1,800	182																				
2,000	202																				
2,200	222																				
2,500	252																				
2,700	272																				
3,300	332																				
3,900	392																				
4,700	472																				
5,600	562																				
6,200	622																				
6,800	682																				
7,500	752																				
8,200	822																				
10,000	103																				

Note: Color breaks used to highlight changes in dielectric material, letters indicate the specific material. Contact factory for higher capacitance values.



RF Capacitors

Single Layer (SLC) - Single Border

S1
SERIES

Single Border (S1 Series) Capacitance Selection:

GPN Code		S1BC				S1BG				S1BL				S1BQ				S1BR				S1BT			
Part Size		0.030" x 0.030"				0.035" x 0.035"				0.040" x 0.040"				0.050" x 0.050"				0.070" x 0.070"				0.090" x 0.090"			
pF	Code	16V	25V	50V	100V	16V	25V	50V	100V	16V	25V	50V	100V	16V	25V	50V	100V	16V	25V	50V	100V	16V	25V	50V	100V
0.1	0R1																								
0.2	0R2																								
0.3	0R3																								
0.4	0R4																								
0.5	0R5																								
0.6	0R6			G	G																				
0.7	0R7			G	G			G	G																
0.8	0R8			G	G			G	G																
0.9	0R9			G	G			G	G																
1.0	1R0			G	G			G	G			G	G												
1.1	1R1			G	G			G	G			G	G												
1.2	1R2			G	G			G	G			G	G												
1.3	1R3			G	G			G	G			G	G												
1.4	1R4			G	G			G	G			G	G												
1.5	1R5			G	G			G	G			G	G			G	G								
1.6	1R6			G	G			G	G			G	G			G	G								
1.7	1R7			G	G			G	G			G	G			G	G								
1.8	1R8			G	G			G	G			G	G			G	G								
1.9	1R9			G	G			G	G			G	G			G	G								
2.0	2R0			G	G			G	G			G	G			G	G								
2.1	2R1			G	G			G	G			G	G			G	G								
2.2	2R2			G	G			G	G			G	G			G	G								
2.4	2R4			G	G			G	G			G	G			G	G								
2.7	2R7			G	G			G	G			G	G			G	G								
3.0	3R0			G	G			G	G			G	G			G	G			G	G				
3.3	3R3			G	G			G	G			G	G			G	G			G	G				
3.6	3R6			G	G			G	G			G	G			G	G			G	G				
3.9	3R9			D	D			G	G			G	G			G	G			G	G				
4.3	4R3			D	D			G	G			G	G			G	G			G	G				
4.7	4R7			D	D			G	G			G	G			G	G			G	G				
5.1	5R1			D	D			G	G			G	G			G	G			G	G			G	G
5.6	5R6			D	D			D	D			G	G			G	G			G	G			G	G
6.2	6R2			D	D			D	D			G	G			G	G			G	G			G	G
6.8	6R8			D	D			D	D			G	G			G	G			G	G			G	G
7.5	7R5			D	D			D	D			D	D			G	G			G	G			G	G
8.2	8R2			D	D			D	D			D	D			G	G			G	G			G	G
9.1	9R1			D	D			D	D			D	D			G	G			G	G			G	G
10	100			E	E			D	D			D	D			G	G			G	G			G	G
12	120			E	E			D	D			D	D			D	D			G	G			G	G
15	150			E	E			E	E			D	D			D	D			G	G			G	G
18	180			P	P			E	E			E	E			D	D			G	G			G	G
20	200			P	P			E	E			E	E			D	D			G	G			G	G
22	220			P	P			E	E			E	E			D	D			D	D			G	G
27	270			P	P			P	P			E	E			E	E			D	D			G	G
33	330			P	P			P	P			P	P			E	E			D	D			G	G
39	390			P	P			P	P			P	P			E	E			D	D			D	D
47	470			P	P			P	P			P	P			E	E			D	D			D	D
50	500			P	P			P	P			P	P			E	E			D	D			D	D
51	510			P	P			P	P			P	P			E	E			D	D			D	D
56	560			W	W			P	P			P	P			P	P			E	E			D	D
68	680			W	W			P	P			P	P			P	P			E	E			D	D
75	750			W	W			P	P			P	P			P	P			E	E			D	D
82	820			W	W			W	W			P	P			P	P			E	E			D	D



RF Capacitors

Single Layer (SLC) - Single Border

S1 SERIES

Single Border (S1 Series) Capacitance Selection:

GPN Code		S1BC				S1BG				S1BL				S1BQ				S1BR				S1BT			
Part Size		0.030" x 0.030"				0.035" x 0.035"				0.040" x 0.040"				0.050" x 0.050"				0.070" x 0.070"				0.090" x 0.090"			
pF	Code	16V	25V	50V	100V	16V	25V	50V	100V	16V	25V	50V	100V	16V	25V	50V	100V	16V	25V	50V	100V	16V	25V	50V	100V
100	101			W	W			W	W			P	P			P	P			E	E			E	E
120	121	A	A	A	W			W	W			W	W			P	P			P	P			E	E
150	151	A	A	A	W			W	W			W	W			P	P			P	P			E	E
180	181	A	A	A	W	A	A	A	W			W	W			W	W			P	P			P	P
200	201	A	A	A	U	A	A	A	W			W	W			W	W			P	P			P	P
220	221	A	A	A	U	A	A	A	W	A	A	A	W			W	W			P	P			P	P
270	271	A	A	A	U	A	A	A	U	A	A	A	W			W	W			P	P			P	P
330	331	A	A	A	Y	A	A	A	U	A	A	A	U	A	A	A	W			W	W			P	P
390	391	A	A	A	Y	A	A	A	U	A	A	A	U	A	A	A	W			W	W			P	P
470	471	A	A	Y	Y	A	A	A	Y	A	A	A	U	A	A	A	W			W	W			P	P
560	561	A	A	Y	Y	A	A	A	Y	A	A	A	U	A	A	A	U			W	W			W	W
680	681	A	A			A	A	Y	Y	A	A	A	Y	A	A	A	U	A	A	A	W			W	W
750	751	A	A			A	A	Y	Y	A	A	A	Y	A	A	A	U	A	A	A	W			W	W
820	821	A	A			A	A	Y	Y	A	A	Y	Y	A	A	A	U	A	A	A	W			W	W
1,000	102	A				A	A			A	A	Y	Y	A	A	A	W			A	A			W	W
1,200	122	A				A				A	A			A	A	Y	Y	A	A	A	U			W	W
1,500	152	A				A				A	A			A	A	Y	Y	A	A	A	U	A	A	A	W
1,800	182					A				A				A	A	Y	Y	A	A	A	U	A	A	A	U
2,000	202					A				A				A	A			A	A	A	Y	A	A	A	U
2,200	222					A				A				A	A			A	A	A	Y	A	A	A	U
2,500	252									A				A				A	A	Y	Y	A	A	A	U
2,700	272									A				A				A	A	Y	Y	A	A	A	U
3,300	332													A				A	A	Y	Y	A	A	A	Y
3,900	392													A				A	A			A	A	A	Y
4,700	472																	A				A	A	Y	Y
5,600	562																	A				A	A	Y	Y
6,200	622																	A				A	A		
6,800	682																	A				A	A		
7,500	752																	A				A	A		
8,200	822																	A				A			
10,000	103																					A			

Note: Color breaks used to highlight changes in dielectric material, letters indicate the specific material. Contact factory for higher capacitance values.



RF Capacitors

Single Layer (SLC) - Dual Border

S2
SERIES

GPN = Global Part Number
S2 = Dual Border

S2 Series Configuration

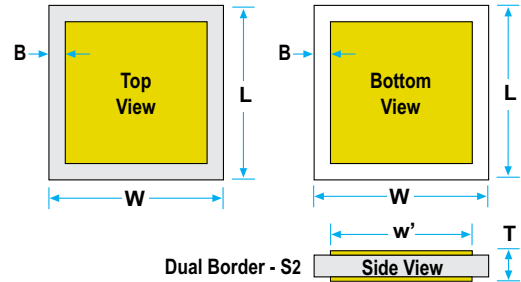

S2 Series Mechanical Characteristics:

GPN Code		Width (W) & Length (L)	Border (B)	Thickness (T)	Thickness for A-Dielectric	
S2AA	inch	0.010" ± 0.001"	0.001" (0.0005" min.)	0.006" ± 0.0025" 0.153mm ± 0.064mm	0.007" ± 0.002" 0.177mm ± 0.051mm	
	mm	0.254mm ± 0.025mm	0.025mm, (0.013mm min.)			
S2AG	inch	0.012" ± 0.001"	0.001" (0.0005" min.)			
	mm	0.305mm ± 0.025mm	0.025mm, (0.013mm min.)			
S2AL	inch	0.015" ± 0.001"	0.002" ± 0.001" 0.051mm ± 0.025mm			
	mm	0.381mm ± 0.025mm				
S2AP	inch	0.020" ± 0.001"				
	mm	0.508mm ± 0.025mm				
S2AU	inch	0.025" ± 0.001"				
	mm	0.635mm ± 0.025mm				
S2BC	inch	0.030" ± 0.001"				0.003" ± 0.001" 0.076mm ± 0.025mm
	mm	0.762mm ± 0.025mm				
S2BG	inch	0.035" ± 0.001"				
	mm	0.889mm ± 0.025mm				
S2BL	inch	0.040" ± 0.001"				
	mm	1.016mm ± 0.025mm				
S2BQ	inch	0.050" ± 0.05"				
	mm	1.270mm ± 0.127mm				
S2BR	inch	0.070" ± 0.05"				
	mm	1.778mm ± 0.127mm				
S2BT	inch	0.090" ± 0.05"				
	mm	2.286mm ± 0.127mm				



RF Capacitors

Single Layer (SLC) - Dual Border

S2
SERIES

Recessed SLC electrode borders help prevent shorting from conductive epoxy squeeze-up and aid visual recognition equipment. The V-Series SLCs feature dual borders (top & bottom) while the B-Series SLCs feature a single border (top-only).

Dual Border (S2 Series) Capacitance Selection:

GPN Code		S2AA				S2AG				S2AL				S2AP				S2AU				
Part Size		0.010" x 0.010"				0.012" x 0.012"				0.015" x 0.015"				0.020" x 0.020"				0.025" x 0.025"				
pF	Code	16V	25V	50V	100V	16V	25V	50V	100V	16V	25V	50V	100V	16V	25V	50V	100V	16V	25V	50V	100V	
0.1	0R1			G	G			G	G													
0.2	0R2			G	G			G	G			G	G			G	G					
0.3	0R3			G	G			G	G			G	G			G	G					
0.4	0R4			D	D			G	G			G	G			G	G			G	G	
0.5	0R5			D	D			G	G			G	G			G	G			G	G	
0.6	0R6			D	D			D	D			G	G			G	G			G	G	
0.7	0R7			D	D			D	D			G	G			G	G			G	G	
0.8	0R8			E	E			D	D			D	D			G	G			G	G	
0.9	0R9			E	E			D	D			D	D			G	G			G	G	
1.0	1R0			E	E			D	D			D	D			G	G			G	G	
1.1	1R1			E	E			D	D			D	D			G	G			G	G	
1.2	1R2			E	E			D	D			D	D			G	G			G	G	
1.3	1R3			E	E			E	E			D	D			G	G			G	G	
1.4	1R4			E	E			E	E			D	D			G	G			G	G	
1.5	1R5			E	E			E	E			D	D			D	D			G	G	
1.6	1R6			P	P			E	E			D	D			D	D			G	G	
1.7	1R7			P	P			E	E			D	D			D	D			G	G	
1.8	1R8			P	P			E	E			D	D			D	D			G	G	
1.9	1R9			P	P			E	E			E	E			D	D			G	G	
2.0	2R0			P	P			E	E			E	E			D	D			G	G	
2.1	2R1			P	P			E	E			E	E			D	D			G	G	
2.2	2R2			P	P			E	E			E	E			D	D			G	G	
2.4	2R4			P	P			P	P			E	E			D	D			G	G	
2.7	2R7			P	P			P	P			E	E			D	D			D	D	
3.0	3R0			P	P			P	P			E	E			D	D			D	D	
3.3	3R3			P	P			P	P			E	E			D	D			D	D	
3.6	3R6			P	P			P	P			P	P			E	E			D	D	
3.9	3R9			P	P			P	P			P	P			E	E			D	D	
4.3	4R3			P	P			P	P			P	P			E	E			D	D	
4.7	4R7			P	P			P	P			P	P			E	E			D	D	
5.1	5R1			W	W			P	P			P	P			E	E			D	D	
5.6	5R6			W	W			P	P			P	P			E	E			D	D	
6.2	6R2			W	W			P	P			P	P			E	E			E	E	
6.8	6R8			W	W			P	P			P	P			P	P			E	E	
7.5	7R5			W	W			W	W			P	P			P	P			E	E	
8.2	8R2			W	W			W	W			P	P			P	P			E	E	
9.1	9R1			W	W			W	W			P	P			P	P			E	E	
10	100			W	W			W	W			P	P			P	P			E	E	
12	120			W	W			W	W			W	W			P	P			P	P	
15	150			W	W			W	W			W	W			P	P			P	P	
18	180			U	U			W	W			W	W			P	P			P	P	
20	200			U	U			W	W			W	W			P	P			P	P	
22	220			U	U			W	W			W	W			W	W			P	P	
27	270			U	U			U	U			W	W			W	W			P	P	
33	330			Y	Y			U	U			W	W			W	W			P	P	
39	390			Y	Y			U	U			U	U			W	W			W	W	
47	470			Y	Y			Y	Y			U	U			W	W			W	W	



RF Capacitors

Single Layer (SLC) - Dual Border

S2
SERIES

Dual Border (S2 Series) Capacitance Selection:

GPN Code		S2AA				S2AG				S2AL				S2AP				S2AU			
Part Size		0.010" x 0.010"				0.012" x 0.012"				0.015" x 0.015"				0.020" x 0.020"				0.025" x 0.025"			
pF	Code	16V	25V	50V	100V	16V	25V	50V	100V	16V	25V	50V	100V	16V	25V	50V	100V	16V	25V	50V	100V
50	500			Y	Y			Y	Y			U	U			W	W			W	W
51	510			Y	Y			Y	Y			U	U			W	W			W	W
56	560	A	A			A	A	Y	Y	A	A	A	U	A	A	A	W			W	W
68	680	A	A			A	A	Y	Y	A	A	A	Y	A	A	A	W			W	W
75	750	A				A	A	Y	Y	A	A	A	Y	A	A	A	U			W	W
82	820	A				A	A	Y	Y	A	A	A	Y	A	A	A	U	A	A	A	W
100	101	A				A	A			A	A	Y	Y	A	A	A	U	A	A	A	W
120	121	A				A				A	A	Y	Y	A	A	A	U	A	A	A	U
150	151					A				A	A			A	A	A	Y	A	A	A	U
180	181					A				A				A	A	Y	Y	A	A	A	U
200	201					A				A				A	A	Y	Y	A	A	A	U
220	221									A				A	A	Y	Y	A	A	A	Y
270	271									A				A	A			A	A	Y	Y
330	331													A				A	A	Y	Y
390	391													A				A	A	Y	Y
470	471													A				A	A		
560	561													A				A			
680	681																	A			
750	751																	A			
820	821																	A			
1,000	102																	A			
1,200	122																				
1,500	152																				
1,800	182																				
2,000	202																				
2,200	222																				
2,500	252																				
2,700	272																				
3,300	332																				
3,900	392																				
4,700	472																				
5,600	562																				
6,200	622																				
6,800	682																				
7,500	752																				
8,200	822																				
10,000	103																				

Note: Color breaks used to highlight changes in dielectric material, letters indicate the specific material. Contact factory for higher capacitance values.



RF Capacitors

Single Layer (SLC) - Dual Border

S2
SERIES

Dual Border (S2 Series) Capacitance Selection:

GPN Code		S2BC				S2BG				S2BL				S2BQ				S2BR				S2BT			
Part Size		0.030" x 0.030"				0.035" x 0.035"				0.040" x 0.040"				0.050" x 0.050"				0.070" x 0.070"				0.090" x 0.090"			
pF	Code	16V	25V	50V	100V	16V	25V	50V	100V	16V	25V	50V	100V	16V	25V	50V	100V	16V	25V	50V	100V	16V	25V	50V	100V
0.1	0R1																								
0.2	0R2																								
0.3	0R3																								
0.4	0R4																								
0.5	0R5			G	G																				
0.6	0R6			G	G																				
0.7	0R7			G	G			G	G																
0.8	0R8			G	G			G	G																
0.9	0R9			G	G			G	G			G	G												
1.0	1R0			G	G			G	G			G	G												
1.1	1R1			G	G			G	G			G	G												
1.2	1R2			G	G			G	G			G	G												
1.3	1R3			G	G			G	G			G	G												
1.4	1R4			G	G			G	G			G	G			G	G								
1.5	1R5			G	G			G	G			G	G			G	G								
1.6	1R6			G	G			G	G			G	G			G	G								
1.7	1R7			G	G			G	G			G	G			G	G								
1.8	1R8			G	G			G	G			G	G			G	G								
1.9	1R9			G	G			G	G			G	G			G	G								
2.0	2R0			G	G			G	G			G	G			G	G								
2.1	2R1			G	G			G	G			G	G			G	G								
2.2	2R2			G	G			G	G			G	G			G	G								
2.4	2R4			G	G			G	G			G	G			G	G								
2.7	2R7			G	G			G	G			G	G			G	G								
3.0	3R0			G	G			G	G			G	G			G	G			G	G				
3.3	3R3			G	G			G	G			G	G			G	G			G	G				
3.6	3R6			G	D			G	G			G	G			G	G			G	G				
3.9	3R9			D	D			G	G			G	G			G	G			G	G				
4.3	4R3			D	D			G	G			G	G			G	G			G	G				
4.7	4R7			D	D			G	G			G	G			G	G			G	G			G	G
5.1	5R1			D	D			D	D			G	G			G	G			G	G			G	G
5.6	5R6			D	D			D	D			G	G			G	G			G	G			G	G
6.2	6R2			D	D			D	D			G	G			G	G			G	G			G	G
6.8	6R8			D	D			D	D			D	D			G	G			G	G			G	G
7.5	7R5			D	D			D	D			D	D			G	G			G	G			G	G
8.2	8R2			D	D			D	D			D	D			G	G			G	G			G	G
9.1	9R1			E	E			D	D			D	D			G	G			G	G			G	G
10	100			E	E			D	D			D	D			G	G			G	G			G	G
12	120			E	E			D	D			D	D			D	D			G	G			G	G
15	150			E	E			E	E			D	D			D	D			G	G			G	G
18	180			E	E			E	E			E	E			D	D			G	G			G	G
20	200			P	P			E	E			E	E			D	D			G	G			G	G
22	220			P	P			E	E			E	E			D	D			D	D			G	G
27	270			P	P			P	P			E	E			E	E			D	D			G	G
33	330			P	P			P	P			P	P			E	E			D	D			G	G
39	390			P	P			P	P			P	P			E	E			D	D			D	D
47	470			P	P			P	P			P	P			E	E			D	D			D	D
50	500			P	P			P	P			P	P			E	E			D	D			D	D
51	510			P	P			P	P			P	P			P	P			E	E			D	D
56	560			W	W			P	P			P	P			P	P			E	E			D	D
68	680			W	W			P	P			P	P			P	P			E	E			D	D



RF Capacitors

Single Layer (SLC) - Dual Border

S2
SERIES

Dual Border (S2 Series) Capacitance Selection:

GPN Code		S2BC				S2BG				S2BL				S2BQ				S2BR				S2BT			
Part Size		0.030" x 0.030"				0.035" x 0.035"				0.040" x 0.040"				0.050" x 0.050"				0.070" x 0.070"				0.090" x 0.090"			
pF	Code	16V	25V	50V	100V	16V	25V	50V	100V	16V	25V	50V	100V	16V	25V	50V	100V	16V	25V	50V	100V	16V	25V	50V	100V
75	750			W	W			W	W			P	P			P	P			E	E			D	D
82	820			W	W			W	W			P	P			P	P			E	E			D	D
100	101			W	W			W	W			W	W			P	P			P	P			E	E
120	121	A	A	A	W			W	W			W	W			P	P			P	P			E	E
150	151	A	A	A	W			W	W			W	W			W	W			P	P			E	E
180	181	A	A	A	U	A	A	A	W			W	W			W	W			P	P			P	P
200	201	A	A	A	U	A	A	A	W			W	W			W	W			P	P			P	P
220	221	A	A	A	U	A	A	A	W	A	A	A	W			W	W			P	P			P	P
270	271	A	A	A	U	A	A	A	U	A	A	A	W			W	W			P	P			P	P
330	331	A	A	A	Y	A	A	A	U	A	A	A	U	A	A	A	W			W	W			P	P
390	391	A	A	A	Y	A	A	A	U	A	A	A	U	A	A	A	W			W	W			P	P
470	471	A	A	Y	Y	A	A	A	Y	A	A	A	U	A	A	A	W			W	W			P	P
560	561	A	A	Y	Y	A	A	Y	Y	A	A	A	U	A	A	A	U			W	W			W	W
680	681	A	A			A	A	Y	Y	A	A	A	Y	A	A	A	U	A	A	A	W			W	W
750	751	A	A			A	A	Y	Y	A	A	Y	Y	A	A	A	U	A	A	A	W			W	W
820	821	A				A	A	Y	Y	A	A	Y	Y	A	A	A	U	A	A	A	W			W	W
1,000	102	A				A	A			A	A	Y	Y	A	A	A	Y	A	A	A	U			W	W
1,200	122	A				A				A	A			A	A	Y	Y	A	A	A	U			W	W
1,500	152	A				A				A				A	A	Y	Y	A	A	A	U	A	A	A	W
1,800	182					A				A				A	A			A	A	A	Y	A	A	A	U
2,000	202					A				A				A	A			A	A	A	Y	A	A	A	U
2,200	222									A				A				A	A	A	Y	A	A	A	U
2,500	252									A				A				A	A	Y	Y	A	A	A	U
2,700	272									A				A				A	A	Y	Y	A	A	A	U
3,300	332													A				A	A	Y	Y	A	A	A	Y
3,900	392													A				A	A			A	A	Y	Y
4,700	472																	A				A	A	Y	Y
5,600	562																	A				A	A	Y	Y
6,200	622																	A				A	A		
6,800	682																	A				A	A		
7,500	752																	A				A	A		
8,200	822																	A				A			
10,000	103																					A			

Note: Color breaks used to highlight changes in dielectric material, letters indicate the specific material. Contact factory for higher capacitance values.



RF Capacitors
Single Layer (SLC)

HOW TO ORDER

S0	AA	500	G	0R1	A	1	ZZ	001	W
Subfamily	Size	Voltage	DTC	Capacitance	Tolerance	Mark	Termination	Special Code	Pack
S0 = No border S1 = Single border S2 = Dual border	AA = .010" x .010" AG = .012" x .012" AL = .015" x .015" AP = .020" x .020" AU = .025" x .025" BC = .030" x .030" BG = .035" x .035" BL = .040" x .040" BQ = .050" x .050" BR = .070" x .070" BT = .090" x .090"	160 = 16V 250 = 25V 500 = 50V 101 = 100V	A = GBBL ultra high-K D = P3L E = R3L G = NP0 P = X7P W = X7R U = Z5U high-K Y = Y5V high-K	1st two digits are significant; 3rd digit denotes number of zeros. 0R5 = 0.5pF 100 = 10pF 102 = 1000 pF	A = ±0.05pF B = ±0.1pF C = ±0.25pF D = ±0.5pF F = ±1% G = ±2% J = ±5% K = ±10% M = ±20% X = +80%/-20%	1 = No mark	S0 = TiW/Pt/Au S1 = TiW/Ni/Au S2 = TiW/Au ZZ = Special code	001 = Default catalog item 003 = 1st special code	B = Bulk W = Waffle pack D = Gel pack S = Ring frame

Example: **S0AA500G0R1A1ZZ001W** No bord, .010" x .010", 50V, NP0/C0G, 0.1pF, ±0.05pF, No mark, Special code, Default catalog item, Waffle pack

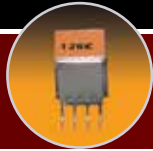

Capacitors (SMPS) Switchmode® Stacked

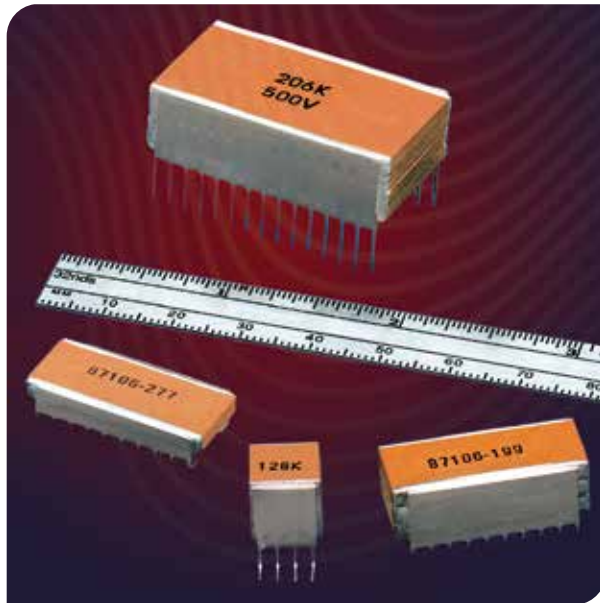

Features

- NP0 & X7R Dielectrics, 50 to 500 VDC Ratings
- Custom Sizes, Voltages, and Values Available
- P-Series Approved to DSCC Drawings 87106 & 88011 MIL-PRF-49470
- New T-Series 200°C for down-hole tools and aircraft engine control applications
- E-Series Common European Lead Styles available to MIL-PRF-49470 requirements

Common Applications

- Voltage Multipliers
- High Voltage Power Supplies
- Very High Frequency Switchers

HOW TO ORDER

M	2	EM	201	B	474	K	3	J1	001	W
Subfamily	# of Chips	Size	Voltage	DTC	Capacitance	Tolerance	Mark	Termination	Special Code	Pack
L = P Series PME M = P Series PME D = E Series BME E = E Series PME R = T Series BME T = T Series PME	1 = 1 Chip 2 = 2 Chips 3 = 3 Chips 4 = 4 Chips 5 = 5 Chips N1 = BME Mini SM 1 Chip N2 = BME Min SM 2 Chips	See chart table "Cap Values & Mechanical Characteristics"	500 = 50V 101 = 100V 201 = 200V 501 = 500V	G = NP0/ COG N = NP0 B = BX W = X7R	1st two digits are significant. 3rd digit denotes number of zeros. 101 = 100pF 102 = 1000pF	J = ±5% K = ±10% L = ±15% M = ±20% N = ±30% X = +80%/-20% P = +100%/0%	1 = No Mark 3 = Cap Code & Tol Z = Special Code	J1 = J Lead J2 = J Lead with reduced height J3 = J Lead (RoHS) J4 = J Lead with reduced height (RoHS) L1 = L Lead L2 = L Lead with reduced height L3 = L Lead (RoHS) L4 = L Lead with reduced height (RoHS) SL = Straight Lead SR = Straight Lead (RoHS)	001 = Default Catalog Item 003 = 1st special code 999 = Last Special Code	T = Tape & Reel W = Waffle Pack F = Packaged in foam Z = Special

Example: **M2EM201B474K3J1001W** Capacitors SMPS P-Series - 2 chips, 2324, BX, 200V, 0.47µF±10%, "J" Leads, Waffle Pack



Capacitors (SMPS) Switchmode® Stacked

Capacitance Values & Mechanical

Characteristics (American Case Size)

Size Code	NPO Max Capacitance (µF)				BX Max Capacitance (µF)				X7R Max Capacitance (µF)				Mechanical Characteristics						Leads Per Side	
	50V	100V	200V	500V	50V	100V	200V	500V	50V	100V	200V	500V	A	B	C	D	D	E		F
EM	0.07	0.05	0.04	0.02	1.3	.70	.37	.17	3.0	2.2	1.0	.50	.120	.185	.250	0.224	0.275	.300	.080	3
	0.14	0.10	0.08	.04	2.6	1.4	.074	0.34	6.0	4.4	2.0	1.0	.240	.305						
	0.21	0.15	0.12	0.06	3.9	2.1	1.1	0.51	9	6.6	3.0	1.5	.360	.425						
	0.28	0.20	0.16	0.08	5.2	2.8	1.5	0.68	12	8.8	4.0	2.0	.480	.545						
	0.35	0.25	0.20	0.10	6.5	3.5	1.8	0.85	15	11	5.0	2.5	.650	.715						
FP	0.22	0.15	0.12	0.07	4.0	2.0	1.1	0.50	9	6.5	3.0	1.5	.120	.185	.400	0.350	0.425	.440	.180	4
	0.44	0.30	0.24	0.14	8.0	4.0	2.2	1.0	18	13	6	3.0	.240	.305						
	0.66	0.45	0.36	0.21	12	6.0	3.3	1.5	27	19	9	4.5	.360	.425						
	0.88	0.60	.48	0.28	16	8	4.4	2.0	36	26	12	6.0	.480	.545						
	1.1	0.75	0.60	0.35	20	10	5.5	2.5	45	32	15	7.5	.650	.715						
NF	0.70	0.50	0.39	0.22	10	6.8	3.5	1.5	28	20	9.5	4.7	.120	.185	.450	0.950	1.075	.500	.180	10
	1.4	1.0	0.78	0.44	20	13	7.0	3.0	56	40	19	9.4	.240	.305						
	2.1	1.5	1.2	0.66	30	20	10	4.5	84	60	28	14	.360	.425						
	2.8	2.0	1.5	0.88	40	27	14	6.0	112	80	38	18	.480	.545						
	3.5	2.5	2.0	1.1	50	34	17	7.5	140	100	47	23	.650	.715						
NF	1.4	1.0	0.75	0.44	20	13	7	3.	50	4	19	9.4	.120	.185	.450	1.850	2.075	.500	.180	2
	2.8	2.0	1.5	0.88	40	27	14	6.0	100	80	38	18	.240	.305						
	4.2	3.0	2.2	1.3	60	40	21	9.0	150	120	57	27	.360	.425						
	5.6	4.0	3.0	1.8	80	54	28	12	200	160	76	36	.480	.545						
	7.0	5.0	3.7	2.2	100	68	35	15	250	200	95	46	.650	.715						
NF	2.0	1.4	1.0	0.6	30	19	10	5	75	55	25	14	.120	.185	.800	1.450	1.535	.870	.530	15
	4.0	2.8	2.0	1.2	60	38	20	9	150	110	50	28	.240	.305						
	6.0	4.2	3.0	1.8	90	57	30	13	220	160	75	42	.360	.425						
	8.0	5.6	4.0	2.4	120	76	40	18	300	220	100	56	.480	.545						
	10	7.0	5.0	3.0	150	95	50	22	370	270	125	70	.650	.715						
HM	4.0	2.8	2.2	1.2	69	40	20	9	16	110	50	25	.120	.185	1.250	1.950	2.075	1.350	.980	20
	8	5.6	4.4	2.4	130	80	40	18	320	220	100	50	.240	.305						
	12	8.4	6.6	3.6	200	120	60	27	480	330	150	75	.360	.425						
	16	11	8.8	4.8	270	160	80	36	640	440	200	100	.480	.545						
	20	14	11	6	340	200	100	45	800	550	250	125	.650	.715						

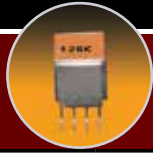

Capacitors (SMPS) Switchmode® Stacked

Capacitance Values & Mechanical Characteristics
(European Case Size)

Size Code	NP0 Max Capacitance (µF)				BX Max Capacitance (µF)				X7R Max Capacitance (µF)				Mechanical Characteristics								Leads Per Side
	50V	100V	200V	500V	50V	100V	200V	500V	50V	100V	200V	500V	A (max)		C +/- 0.5mm (.20")		D (max)		E (max)		
	mm	In	mm	In	mm	In	mm	In	mm	In	mm	In	mm	In	mm	In	mm	In	mm	In	
HM	0.13	0.09	0.07	0.045	2.2	1.5	0.8	0.35	5.0	4.0	2.5	1.0	3.8	0.150	8.2	0.322	8.7	.0342	9.2	0.362	3
	0.26	0.18	0.14	0.09	4.4	3.0	1.6	0.70	10	8.0	5.0	2.0	7.4	0.291							
	0.39	0.27	0.21	0.13	6.6	4.5	2.4	1.0	15	12	7.5	3.0	11.1	0.437							
	0.52	0.36	0.28	0.18	8.8	6.0	3.2	1.4	20	16	10	4.0	14.8	0.583							
HM	0.22	0.15	0.12	0.08	3.9	2.5	1.4	0.60	9.0	6.5	4.0	1.8	3.8	0.150	10.2	0.400	10.7	.0421	10.7	0.421	4
	0.44	0.30	0.24	0.16	7.8	5.0	2.8	1.2	18	13	8.0	3.6	7.4	0.291							
	0.66	0.45	0.36	0.24	11	7.5	4.2	1.8	27	19	12	5.4	11.1	0.437							
	0.88	0.60	0.48	0.32	15	10	5.5	3.0	36	26	16	7.2	14.8	0.583							
HM	0.4	0.30	0.22	0.15	7.0	4.5	2.5	1.0	16	12	7.5	3.3	3.8	0.150	14.0	0.551	13.6	0.535	14.9	0.586	5
	0.8	0.60	0.44	0.30	14	9.0	5.0	2.0	32	24	15	6.6	7.4	1.150							
	1.2	0.90	0.66	0.45	21	13	7.5	3.0	48	36	22	9.9	11.1	0.437							
	1.6	1.2	0.9	0.60	28	18	10	4.0	64	48	30	13	14.8	0.583							
HV	0.7	0.5	0.40	0.25	13	8.5	4.5	2.0	30	22	14	6.0	3.8	0.150	15.2	0.600	21.6	0.850	16.8	0.661	5
	1.4	1.0	0.8	0.5	26	17	9.0	4.0	60	44	28	12	7.4	0.291							
	2.1	1.5	1.2	0.8	39	25	13	6.0	90	66	42	18	11.1	0.437							
	2.8	2.0	1.6	1.0	52	34	18	8.0	120	88	56	24	14.8	0.583							
ND	0.7	0.5	0.40	0.25	13	8.5	4.5	2.2	30	22	14	6.0	3.8	0.150	20.3*	0.800*	16.6	0.653	21.6	0.850	6
	1.4	1.0	0.8	0.5	26	17	9.0	4.0	60	44	28	12	7.4	0.291							
	2.1	1.5	1.2	0.8	39	25	13	6.0	90	66	42	18	11.1	0.437							
	2.8	2.0	1.6	1.0	52	34	18	8.0	120	88	56	24	14.8	0.583							
ND	0.8	0.6	0.50	.30	15	10	5.5	2.2	35	25	16	7.0	3.8	0.150	10.2	0.400	38.2	1.503	18.9	0.744	14
	1.6	1.2	1.0	0.60	30	20	11	4.4	70	50	32	14	7.4	0.291							
	2.4	1.8	1.5	0.90	45	30	16	6.6	100	75	48	21	11.1	0.437							
	3.2	2.4	2.0	1.2	60	40	22	8.8	140	100	64	28	14.8	0.583							
NK	1.4	1.0	0.75	0.50	24	15	8.5	3.5	50	40	25	11	3.8	0.150	15.2	0.600	38.2	1.503	12.0	0.472	14
	2.8	2.0	1.5	1.0	48	30	17	7.0	100	80	50	22	7.4	0.291							
	3.2	3.0	2.2	2.0	72	45	25	10	150	120	75	33	11.1	0.437							
	5.6	4.0	3.0	3.0	96	60	34	14	200	160	100	44	14.8	0.583							
NM	2.0	1.4	1.0	0.70	33	22	12	5.0	75	50	35	16	3.8	0.150	20.3*	.800*	40.6	1.598	24.0	0.944	14
	4.0	2.8	2.0	1.4	66	44	24	10	150	100	70	32	7.4	0.291							
	6.0	4.2	3.0	2.1	99	66	36	15	220	150	100	48	11.1	0.437							
	8.0	5.6	4.0	2.8	130	88	48	20	300	200	140	64	14.8	0.583							



Capacitors

CapStrate® = Bulk Capacitance Embedded in Substrate

Our new line of CapStrate® products integrate large amounts of bulk capacitance into a ceramic substrate allowing elimination of large discrete capacitive components saving critical space and simplifying your assembly process.

Our extensive experience in design and manufacture of large format, custom geometries allows us to develop unique and innovative solutions which successfully solve a wide variety of our customer's design challenges.

We'll work proactively with you to fully understand your requirements and recommend the best solution compatible with your application needs.

Applications & Features:

- Rated Working Voltages from 50V to 500V, (specials from 1kV to 7.5kV)
- Temperature ranges: -55°C to 125°C (specials to 200°C and 250°C)
- Compact Designs Utilizing Military Grade Ceramics
- Custom Sizes, Values, and Voltages Available
- Integrated Capacitance Substrates

Before

Stacked Capacitors

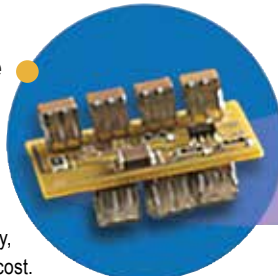

After

CapStrate® Capacitors embedded into substrate

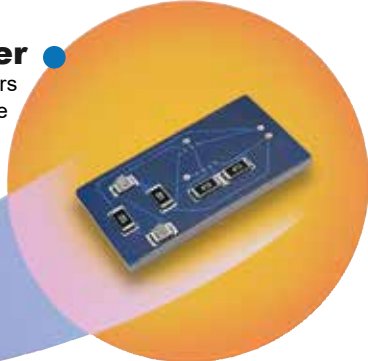

Power Electronic Solutions:
CapStrate® Capacitors embedded into Substrate result into critical space saving, simplifying assembly, fewer solder joints, and lower assembly cost.

Choosing the correct CapStrate® influences the mechanical and electrical function of a design. Johanson Dielectrics offers ceramic substrates for use in application specific environments. It is recommended to choose the right substrate that meets the required electrical requirements and is suitable for the environment the product will operate in.

From . . .

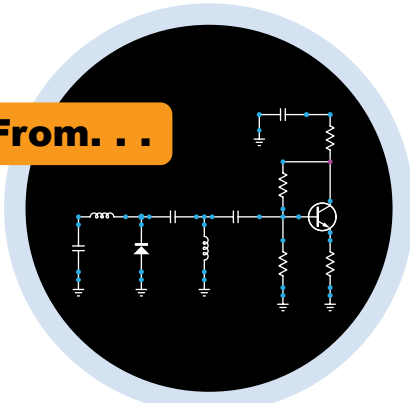

to



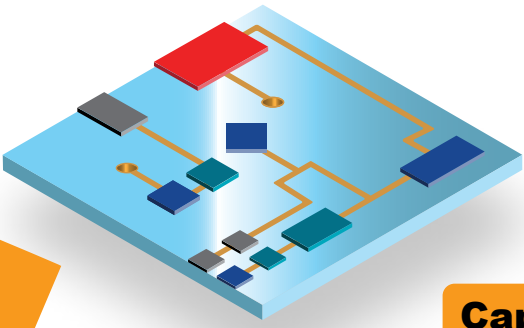

CapStrate®



Capacitors

CapStrate® = Bulk Capacitance Embedded in Substrate

Sizes:

CapStrate® designs are traditionally available in rectangular or circular formats. Our standard size dimensions are listed below for rectangular and circular designs. Unique form factors will be considered.

Additional Features:

- High reliability conductor traces
- Plated and through-hole vias
- Assembly services
- Solder pads

Table 1: Available Material Types & Electrical Properties

Material	X7R	NP0	X8R
Dissipation Factor	<2.5%	<0.15%	<2.5%
Dielectric Strength (V/mil)	200	300	200
Temperature Coefficient	± 15%	0 ± 30 ppm/°C	± 15%
Temperature Range	-55 °C to +125 °C	-55 °C to +125 °C	-55 °C to +150 °C

Table 2: Rectangular Dimensions

Dimension	Minimum	Maximum	Tolerance
Thickness	0.050" (1.27mm)	0.215" (5.461mm)	+/- 0.005 (0.127mm)
Length	0.20" (5.08mm)	2.00"/1.00" (50.8/25.4mm)	+/- 0.005 (0.127mm)
Width	0.20" (5.08mm)	1.00"/2.00" (25.4/50.8mm)	+/- 0.005 (0.127mm)
Temperature Range	-55 °C to +125 °C	-55 °C to +125 °C	-55 °C to +150 °C

Table 3: Circular Dimensions

Dimension	Minimum	Maximum	Tolerance
Thickness	0.050" (1.27mm)	0.215" (5.46mm)	+/- 0.005 (0.127mm)
Diameter	0.20" (5.08mm)	2.00" (50.8mm)	+/- 0.005 (0.127mm)

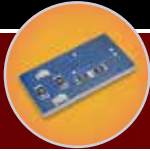

Capacitors

CapStrate® = Bulk Capacitance Embedded in Substrate



Close up of space saving surface traces and components on a rectangular CapStrate®

The advantages of **CapStrate®** Dielectrics can be fully realized by replacing discrete capacitors with bulk capacitance from the ceramic substrates. The amount of capacitance that can be utilized varies depending on the design dimensions.

Tables 4 and 5 reference the maximum amount of capacitance that can be designed for dimensional, substrate and voltage constraints.

Typical voltage ratings vary from 100 to 1000V, however, engineers are invited to discuss special voltage requirements not listed below.

Table 4: Rectangular Bulk Capacitance (CapStrate®)

NP0	Length	Width	Thickness	100V	250V	500V	1000V
Maximum Size	2.00" (50.8mm)	1.00" (25.4mm)	0.150" (3.81mm)	5000nF	2500nF	1400nF	940nF
Minimum Size	0.20" (5.08mm)	0.20" (5.08mm)	0.050" (1.27mm)	30nF	9nF	5nF	2.8nF

X7R	Length	Width	Thickness	100V	250V	500V	1000V
Maximum Size	2.00" (50.8mm)	1.00" (25.4mm)	0.150" (3.81mm)	120000nF	60000nF	25000nF	8000nF
Minimum Size	0.20" (5.08mm)	0.20" (5.08mm)	0.050" (1.27mm)	800nF	200nF	70nF	20nF

X8R	Length	Width	Thickness	100V	250V	500V	1000V
Maximum Size	2.00" (50.8mm)	1.00" (25.4mm)	0.150" (3.81mm)	84000nF	42000nF	17500nF	5600nF
Minimum Size	0.20" (5.08mm)	0.20" (5.08mm)	0.050" (1.27mm)	560nF	140nF	49nF	14nF

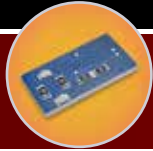

Capacitors

CapStrate® Integrating Bulk Capacitance

- Custom Geometry
- Increased Bulk Capacitance
- High Voltage Capabilities
- Reduction in Size

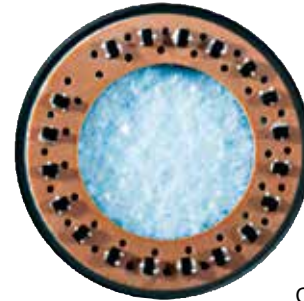

Circular CapStrate®

Table 5: Circular Bulk Capacitance (CapStrate®)

NP0	Diameter	Thickness	100V	250V	500V	1000V	1000V
Maximum Size	2.00" (50.8mm)	0.150" (3.81mm)	7600nF	3800nF	2600nF	1400nF	940nF
Minimum Size	0.20" (5.08mm)	0.050" (1.27mm)	25nF	6nF	3nF	1.7nF	2.8nF

X7R	Diameter	Thickness	100V	250V	500V	1000V	1000V
Maximum Size	2.00" (50.8mm)	0.150" (3.81mm)	180000nF	95000nF	40000nF	12000nF	8000nF
Minimum Size	0.20" (5.08mm)	0.050" (1.27mm)	550nF	140nF	45nF	15nF	20nF

X8R	Diameter	Thickness	100V	250V	500V	1000V	1000V
Maximum Size	2.00" (50.8mm)	0.150" (3.81mm)	126000nF	66500nF	28000nF	8400nF	5600nF
Minimum Size	0.20" (5.08mm)	0.050" (1.27mm)	385nF	98nF	31.5nF	10.5nF	14nF

Additional sizes and form factors not listed are possible. Contact Johanson to assess the feasibility of your design. Reference table 6 for the maximum capacitance density that can be used for a given substrate. **Capacitance density is presented in nF/(mils)³. This is the maximum amount of capacitance available in each volume.**

Table 6: Max Capacitance Density

Rectangular	X7R	NP0	X8R	Circular	X7R	NP0	X8R
100V	4.00E-04	1.67E-05	2.80E-04	100V	3.82E-04	1.61E-02	1.13E-02
250V	2.00E-04	8.33E-06	1.40E-04	250V	2.02E-04	8.10E-03	5.67E-03
500V	8.33E-05	4.67E-06	5.83E-05	500V	8.49E-05	5.51E-03	3.86E-03
1000V	2.67E-05	3.13E-06	1.87E-05	1000V	2.54E-05	2.97E-03	2.08E-03



Capacitors - CapStrate®

Metallization/Solder Pad

Johanson Dielectrics offers a variety of metallization schemes that are high reliability conductors. These metals can be utilized as conductors, solder pads, or methods of thermal transfer. Designers should select the available metal based on the metallization properties that best suit their design. Careful selection of particular metallizations is dependent on requirements for solderability, temperature resistance, and electrical performance.

Table 7: Metallization Schemes Available

Dielectric	Ag / Pt	Ni / Au	Ag / Ni / Au
X7R	X	X	-
X8R	X	X	-
NP0	X	-	X

Table 8: Metallization Properties

Material Property	Ag / Pt	Ni / Au	Ag / Ni / Au
Recommended Thickness	14µm	7-12µ"	Contact Factory
Max Solder Temp	218°C	260°C	230°C

Table 9: Solder Pad Dimensions

Metallization	Length (Minimum)	Width (Minimum)	Pad Spacing (Minimum)
Ag/Pt	0.015" (0.381mm)	0.010" (0.254mm)	0.007" (0.178mm)
Ni/Au	0.015" (0.381mm)	0.010" (0.254mm)	0.007" (0.178mm)
Ag/Ni/Au	0.015" (0.381mm)	0.010" (0.254mm)	0.007" (0.178mm)

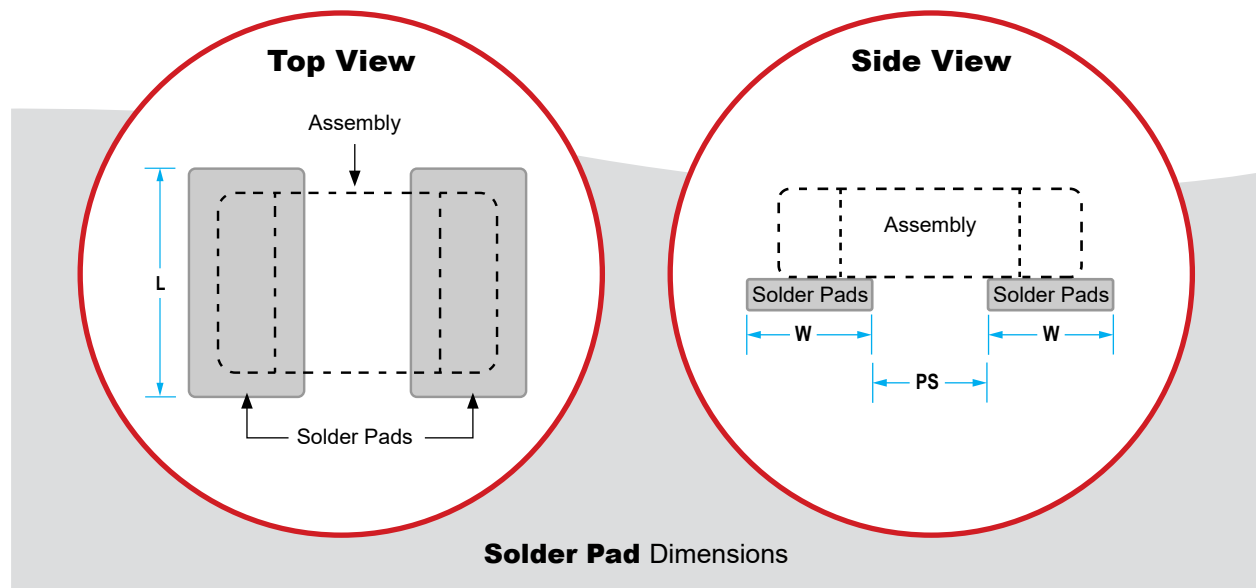

Contact technical team: <https://www.johansondielectrics.com/ask-a-question>



Capacitors

Custom Shape Bulk Capacitance (Custom Solutions)

Custom Solutions!

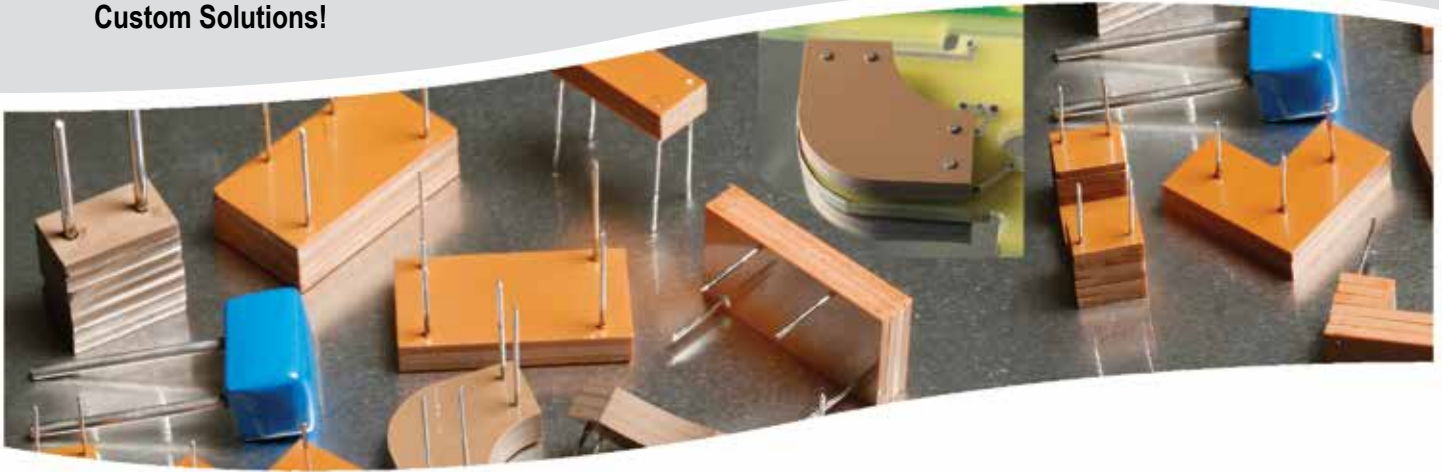

Another custom approach is our variable pitch design. This custom design enables a highly customizable solution for capacitor development. It eliminates constraints of standard catalog options and traditional square or rectangular configurations.

Variable pitch design allows design engineers to specify key parameters, such as:

- Capacitance
- Voltage
- Physical dimensions
- Geometry
- Lead placement

Variable pitch design ensures the resulting capacitor aligns precisely with the technical and performance requirements of the application.

Features:

- Custom shapes to fit specific requirements
- Multiple capacitors in a single assembly
- Multiple pin, lead-frame, and flying wire options
- Bare ceramic, epoxy coated, potted solutions
- NP0/COG and X7R solutions from -55°C to + 125°C

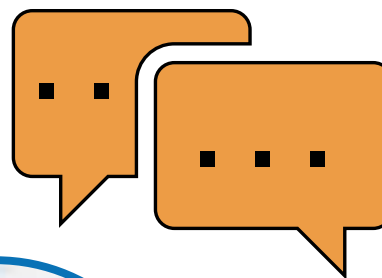

**Send us your
unique design
requirements**

Contact Johanson today!

<https://www.johansondielectrics.com/ask-a-question>



Don't miss the opportunity to work with our outstanding design engineers. Visit our website for more information. We look forward to assisting you with your unique design requirements See "RESOURCE" below.



RF Inductors
Ceramic Inductors



High frequency multi-layer chip inductors feature a monolithic body made of low loss ceramic and high conductivity metal electrodes to achieve optimal high frequency performance.

These RF chip inductors are compact in size and feature lead-free tin plated nickel barrier terminations and tape and reel packaging which makes them ideal for small size/high volume wireless applications.

Applications:

- CELL/PCS Modules
- Wireless LAN
- Broadband Components
- RFID
- RF Transceivers
- RoHS Compliant (Standard, "V" Code)
- Sn/Pb Terminations Optional ("T" Code)

Product Range Summary

EIA SIZE (mm)	RANGE	Q FACTOR (Min.)	SRF (Typ.)	TEMPERATURE
0201 (0603)	0.6 - 39 nH	4 (100 MHz)	>21 GHz (1.0 nH)	-55°C to +100°C
0402 (1005)	1.0 - 120 nH	8 (100 MHz)	>21 GHz (1.0 nH)	-55°C to +100°C
0603 (1608)	1.0 - 220 nH	12 (100 MHz)	>23 GHz (1.0 nH)	-55°C to +100°C



RF Inductors
Ceramic Inductors

Types of Markings

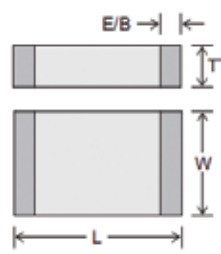

Mechanical Characteristics

Size	0201 (0603)		0402 (1005)		0603 (1608)		Characteristics
	Inches	mm	Inches	mm	Inches	mm	
Length	.024 ± .001"	(0.6 ± 0.03)	.039 ± .004"	(1.00 ± .10)	.063 ± .006"	(1.60 ± .15)	
Width	.012 ± .001"	(0.3 ± 0.03)	.020 ± .004"	(0.50 ± .10)	.031 ± .008"	(0.80 ± .15)	
Thickness	.012 ± .001"	(0.3 ± 0.03)	.020 ± .004"	(0.50 ± .10)	.031 ± .008"	(0.80 ± .15)	
End Band	.006 ± .002"	(0.15 ± 0.05)	.009 ± .004"	(0.23 ± .10)	.012 ± .004"	(0.30 ± .20)	

HOW TO ORDER

LR	C	0402	C	C	1N0	GV	001	B
Subfamily	Ceramic	Size	Type	Tolerance	Value	Termination	Special Code	Packaging
LR = Ceramic Inductor	C = Ceramic	0201 0402 0603	B = Half-marked (all 0201) C = 0402 & 0603 (see "Marking")	C = ± 0.2 nH ≤ 1.0 nH S = ± 0.3 nH 1.0 to 5.6 nH J = ± 5% 6.8 nH and above K = ± 10% 3.3 nH and above	See Table	GV = Ni/Sn (RoHS) NT = Ni/SnPb	001 = Default Catalog Item	B = Bulk (all sizes) T = 7" Reel Paper Tape R = 13" Reel Paper Tape W = Waffle Pack (0603)

Example: LRC0402CC1N0GV001B is Ceramic Inductor, 0402, 1.0nH±0.2nH, 300mA, Ni/Sn (RoHS), Orientation Mark Full Marking, Bulk



RF Inductors
Ceramic Inductors

Inductance Range / Electrical

Characteristics

Inductor Value		EIA Size	0201	0402	0603	
Inductance		Tolerance				
nH	Code					
0.6	0N6	C, S	300 mA			
0.7	0N7		300 mA			
0.8	0N8		300 mA			
0.9	0N9		300 mA			
1.0	1N0		300 mA	300 mA	300 mA (S only)	
1.2	1N2		300 mA	300 mA (S only)	300 mA (S only)	
1.3	1N3		300 mA			
1.5	1N5		300 mA	300 mA (S only)	300 mA (S only)	
1.8	1N8		300 mA	300 mA (S only)	300 mA (S only)	
1.9	1N9		300 mA	300 mA (S only)		
2.0	2N0		300 mA	300 mA (S only)		
2.2	2N2		300 mA	300 mA (S only)	300 mA (S only)	
2.3	2N3		300 mA			
2.4	2N4		300 mA	300 mA (S only)		
2.5	2N5		300 mA			
2.7	2N7		300 mA	300 mA (S only)	300 mA (S only)	
3.0	3N0		300 mA	300 mA (S only)		
3.3	3N3		K, S	300 mA	300 mA	300 mA
3.6	3N6			300 mA	300 mA	
3.7	3N7			300 mA		
3.9	3N9	300 mA		300 mA	300 mA	
4.3	4N3			300 mA		
4.7	4N7	300 mA		300 mA	300 mA	
5.1	5N1	300 mA		300 mA		
5.6	5N6	300 mA		300 mA	300 mA	
6.2	6N2			300 mA		
6.8	6N8	J, K		250 mA	250 mA	300 mA
7.5	7N5			250 mA		
8.2	8N2		250 mA	250 mA	300 mA	
10	10N			250 mA	300 mA	
12	12N		250 mA	250 mA	300 mA	
13	13N		250 mA	250 mA		
15	15N		250 mA	250 mA	300 mA	
18	18N		200 mA	200 mA	300 mA	
22	22N		200 mA	200 mA	300 mA	
23	23N			200 mA		
27	27N		200 mA	200 mA	300 mA	
33	33N		200 mA	200 mA	300 mA	
39	39N		200 mA	150 mA	300 mA	
43	43N			150 mA		
47	47N			150 mA	300 mA	
56	56N			150 mA	300 mA	
68	68N			100 mA	300 mA	
82	82N			100 mA	300 mA	
100	R10			100 mA	300 mA	
120	R12			100 mA	300 mA	
150	R15			300 mA		
180	R18			300 mA		
220	R22			300 mA		
270	R27					
330	R33					
390	R39					
420	R42					
560	R56					
680	R68					



RF Inductors
Ceramic Inductors

RF Characteristics

"Typical"

INDUCTANCE VS FREQUENCY: SIZE 0201

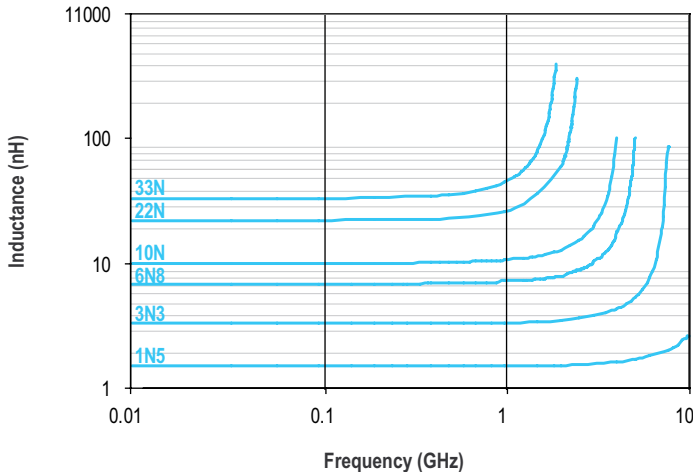

Q VS FREQUENCY: SIZE 0201

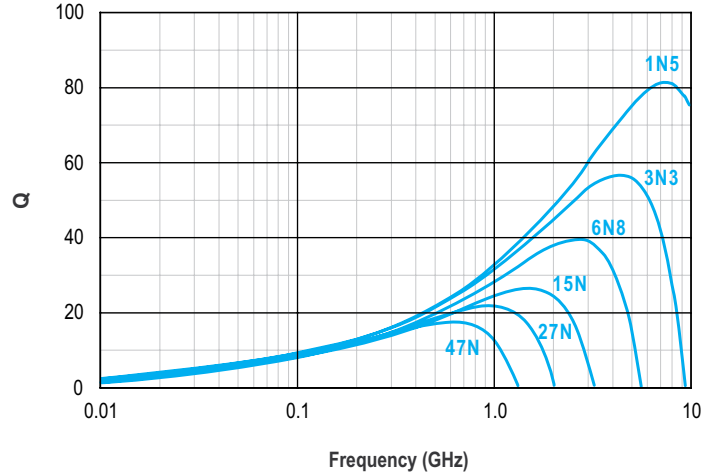

INDUCTANCE VS FREQUENCY: SIZE 0402

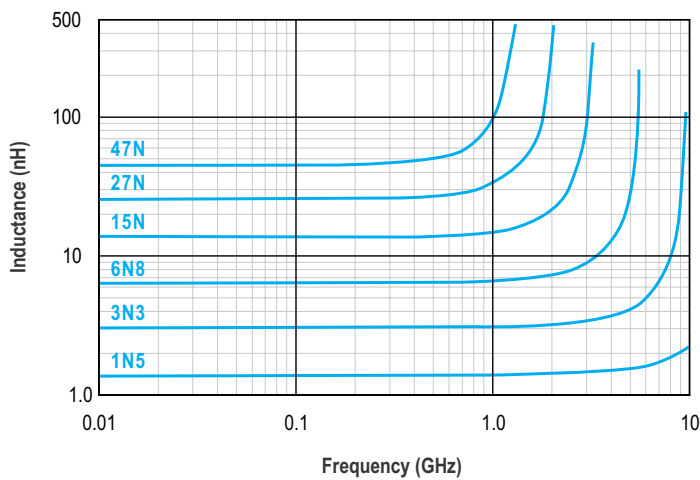

Q VS FREQUENCY: SIZE 0402

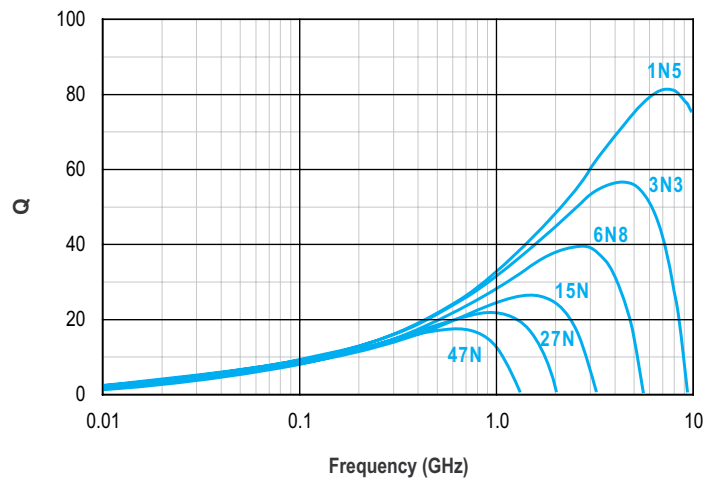

INDUCTANCE VS FREQUENCY: SIZE 0603

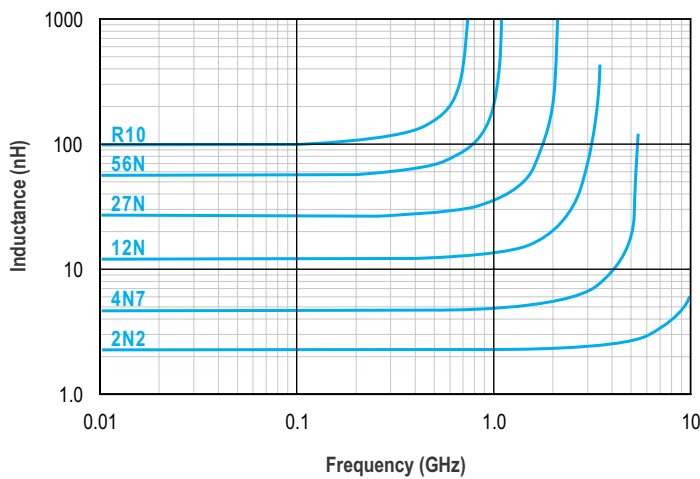

Q VS FREQUENCY: SIZE 0603

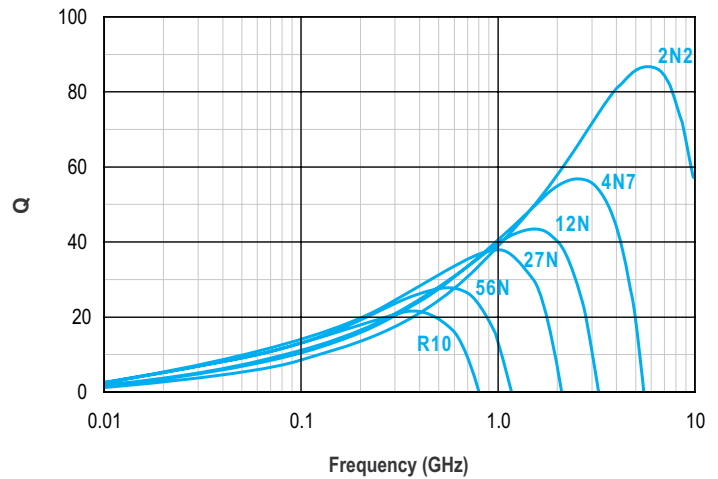



RF Inductors WireWound Inductors

Johanson high frequency High-Q chip inductors feature a monolithic body made of low loss ceramic wound with wire to achieve optimal high frequency performance.

These RF chip inductors are compact in size and are provided on tape and reel packaging which makes them ideal for high volume RF applications. They feature a nickel barrier with a top plating of gold for the ceramic core types (all 0402, all 0603, and most 0805 types), and with a top plating of 100% tin for the ferrite core types (0805 size, 470 nH and higher). Most inductance values between those listed are available on request.

Features:

- Compact in Size
- Provided in Tape and Reel
- Nickel Barrier with a top plating of gold for ceramic core types

Applications:

- CELL/PCS Modules
- Wireless LAN
- Broadband Components
- RF Transceivers
- RFID
- Cordless Phone
- Cable Modem
- Computer Peripherals
- Bluetooth
- ASDL

Product Range Summary

EIA Sie (mm)	Size Code	L Range	Q Factor (Typ.)	SRF(Typ.)	Temperature
0402 (1005)	L-07	1.0 - 120 nH	55 (900 MHz)	>11 GHz (1.0 nH)	-40°C to +125°C
0603 (1608)	L-14	2.0 - 470 nH	60 (900 MHz)	>13 GHz (2.0 nH)	-40°C to +125°C
0805 (2012)	L-15	2.2 - 10,000 nH	60 (500 MHz)	>11 GHz (2.2 nH)	-40°C to +125°C

Mechanical Characteristics

Size	0402 (1005)		0603 (1608)		0805 (2012)	
	Inches	mm	Inches	mm	Inches	mm
Length	.039 ± .004"	(1.00 ± .10)	.039 ± .008"	(1.60 ± .20)	.079 ± .008"	(2.00 ± .20)
Width	.022 ± .004"	(0.55 ± .10)	.041 ± .008"	(1.05 ± .20)	.049 ± .008"	(1.25 ± .20)
Thickness	.020 ± .004"	(0.50 ± .10)	.041 ± .008"	(1.05 ± .20)	.047 ± .008"	(1.20 ± .20)
End Band	.008 ± .004"	(0.20 ± .10)	.014 ± .004"	(0.23 ± .10)	.016 ± .004"	(0.40 ± .10)

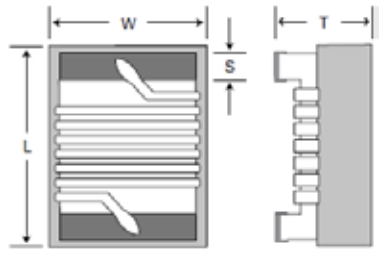

HOW TO ORDER

LR	W	0402	S	1N0	GG	001	T
Device	Type	Size	Tolerance	Value	Termination	Marking	Packaging
LR = Wirewound RF Inductor	W = Wirewound on Ceramic Core	0402 0603 0805	C = ± 0.2 nH S = ± 0.3 n G = ± 2% J = ± 5% K = ± 10%	See chart code on page 78	GG = Ni/Au for "W" types, GV = Ni/Sn for "F" types	001 = Marking	Size Code 0402 T = 7" Reel Paper Tape 0603 E = 7" Reel Emb Tape 0805 E = 7" Reel Emb Tape Bulk (loose pcs) Size Code All B = Bulk

Example: **LRW0402S1N0GG001T** is WireWound Inductors, 0402, 1nH±0.3nH, 1360mA, Ni/Au (RoHS), No Mark, 7" Reel Paper Tape.

*See selection chart on the following pages for available tolerances of each value.



RF Inductors

WireWound Inductors - Chip Summary Chart

EIA Size		0402		0603		0805		Core Type	EIA Size		0402		0603		0805		Core Type						
Inductor Value	Inductance		Tolerance	Rated Current	Tolerance	Rated Current	Tolerance		Rated Current	Inductor Value	Inductance		Tolerance	Rated Current	Tolerance	Rated Current		Tolerance	Rated Current				
	nH	Code									nH	Code								nH	Code	nH	Code
1.0	1N0	C, S	1360 mA	C, S	700 mA	C, S	800 mA	Ceramic Core ("VV" Type)	43	43N	G, J, K	100 mA	G, J, K	700 mA	J, K	600 mA	Ceramic Core ("VV" Type)						
1.2	1N2								1300 mA	700 mA								700 mA	800 mA	47	47N	100 mA	600 mA
1.6	1N6								1040 mA	700 mA	700 mA	800 mA						51	51N	100 mA	600 mA	J, K	600 mA
1.8	1N8								1040 mA	700 mA	700 mA	800 mA						56	56N	100 mA	600 mA	G, J, K	500 mA
1.9	1N9								1040 mA	700 mA	700 mA	800 mA						68	68N	100 mA	600 mA		G, J, K
2.0	2N0								960 mA	700 mA	700 mA	800 mA						72	72N	100 mA	400 mA	J, K	500 mA
2.2	2N2								790 mA	700 mA	700 mA	800 mA						82	82N	100 mA	400 mA		
2.4	2N4								640 mA	700 mA	700 mA	800 mA						100	R10	100 mA	400 mA	G, J, K	500 mA
2.6	2N6								640 mA	700 mA	700 mA	800 mA						110	R11	100 mA			
2.7	2N7								840 mA	700 mA	700 mA	800 mA						120	R12	100 mA	300 mA	G, J, K	500 mA
3.3	3N3								840 mA	700 mA	700 mA	800 mA						150	R15		280 mA		
3.6	3N6								840 mA	700 mA	700 mA	600 mA						180	R18		240 mA	G, J, K	400 mA
3.9	3N9	700 mA	700 mA	700 mA	600 mA	220	R22		200 mA		400 mA												
4.3	4N3	640 mA	700 mA	700 mA	600 mA	270	R27		170 mA		350 mA												
4.7	4N7	800 mA	700 mA	700 mA	600 mA	330	R33		150 mA	J, K	300 mA												
5.1	5N1	760 mA	700 mA	C, J, K	600 mA	390	R39		100 mA			G, J, K	210 mA										
5.6	5N6	760 mA	700 mA	C, J, K	700 mA	470	R47		100 mA	J, K	500 mA	Ceramic											
6.2	6N2	680 mA	700 mA		C, G, J, K	600 mA	560	R56						450 mA									
6.8	6N8	680 mA	700 mA	J, K	600 mA	680	R68						400 mA										
7.5	7N5	680 mA	700 mA	C, G, J, K	600 mA	820	R82						300 mA										
8.2	8N2	480 mA	700 mA			1000	1R0						180 mA										
8.7	8N7	680 mA	700 mA			1200	1R2						150 mA										
9.0	9N0	480 mA	700 mA			1500	1R5						130 mA										
9.5	9N5	640 mA	700 mA			1800	1R8						120 mA										
10	10N	640 mA	700 mA			2200	2R2						J, K	110 mA	Ferrite Core ("F" Type)								
11	11N	560 mA	700 mA	J, K	600 mA	2700	2R7									100 mA							
12	12N	560 mA	700 mA			3300	3R3									210 mA							
13	13N	560 mA	700 mA			3900	3R9									200 mA							
15	15N	420 mA	700 mA			4700	4R7			180 mA													
16	16N	480 mA	700 mA	G, J, K		5600	5R6			160 mA													
18	18N	420 mA	700 mA			6800	6R8			130 mA													
19	19N	420 mA	700 mA			8200	8R2			120 mA													
20	20N	400 mA	700 mA			10000	10R			80 mA													
22	22N	400 mA	700 mA	J, K	600 mA																		
23	23N	400 mA	700 mA																				
24	24N	400 mA	700 mA																				
27	27N	400 mA	700 mA																				
30	30N	400 mA	700 mA	G, J, K																			
33	33N	400 mA	600 mA																				
36	36N	320 mA		J, K	600 mA																		
39	39N	320 mA	600 mA	G, J, K	500 mA																		
40	40N	320 mA																					

Consult Factory for Non-Standard values.



RF Inductors

WireWound Inductors - 0402 Selection Chart

Part Number (Standard Tolerances)	Inductance @ 250MHz	Available Tolerances @ 250MHz	Q (min.) @ 250MHz	Q (Type) @ 900MHz	Q (Type) @ 1.8GHz	SRF (min.)	DC Resistance	Rated Current (max.)
LRW0402WS1N0GG001T	1.0 nH	±0.2 nH, ±0.3 nH	13	49	60	6.0 GHz	0.045 Ω	1360 mA
LRW0402WS1N2GG001T	1.2 nH	±0.2 nH, ±0.3 nH	13	49	60	6.0 GHz	0.060 Ω	1300 mA
LRW0402WS1N8GG001T	1.8 nH	±0.2 nH, ±0.3 nH	16	50	60	6.0 GHz	0.070 Ω	1040 mA
LRW0402WS1N9GG001T	1.9 nH	±0.2 nH, ±0.3 nH	16	50	60	6.0 GHz	0.070 Ω	1040 mA
LRW0402WS2N0GG001T	2.0 nH	±0.2 nH, ±0.3 nH	16	51	62	6.0 GHz	0.070 Ω	1040 mA
LRW0402WS2N2GG001T	2.2 nH	±0.2 nH, ±0.3 nH	18	52	65	6.0 GHz	0.070 Ω	960 mA
LRW0402WS2N2GG001T	2.4 nH	±0.2 nH, ±0.3 nH	15	52	65	6.0 GHz	0.068 Ω	790 mA
LRW0402WS2N7GG001T	2.7 nH	±0.2 nH, ±0.3 nH	16	50	65	6.0 GHz	0.120 Ω	640 mA
LRW0402WJ3N3GG001T	3.3 nH	±0.2 nH, ±5%, ±10%	19	53	72	6.0 GHz	0.066 Ω	840 mA
LRW0402WJ3N6GG001T	3.6 nH	±0.2 nH, ±5%, ±10%	19	55	72	6.0 GHz	0.066 Ω	840 mA
LRW0402WJ3N9GG001T	3.9 nH	±0.2 nH, ±5%, ±10%	19	60	76	5.8 GHz	0.066 Ω	840 mA
LRW0402WJ4N3GG001T	4.3 nH	±0.2 nH, ±5%, ±10%	18	55	82	6.0 GHz	0.091 Ω	700 mA
LRW0402WJ4N7GG001T	4.7 nH	±0.2 nH, ±5%, ±10%	15	55	82	4.8 GHz	0.130 Ω	640 mA
LRW0402WJ5N1GG001T	5.1 nH	±0.2 nH, ±5%, ±10%	20	58	83	5.8 GHz	0.083 Ω	800 mA
LRW0402WJ5N6GG001T	5.6 nH	±0.2 nH, ±5%, ±10%	20	61	89	5.8 GHz	0.083 Ω	760 mA
LRW0402WJ6N2GG001T	6.2 nH	±0.2 nH, ±5%, ±10%	20	57	80	5.8 GHz	0.083 Ω	760 mA
LRW0402WJ6N8GG001T	6.8 nH	±0.2 nH, ±5%, ±10%	20	58	80	4.8 GHz	0.083 Ω	680 mA
LRW0402WJ7N5GG001T	7.5 nH	±0.2 nH, ±5%, ±10%	22	59	90	5.8 GHz	0.104 Ω	680 mA
LRW0402WJ8N2GG001T	8.2 nH	±0.2 nH, ±5%, ±10%	22	60	87	4.4 GHz	0.104 Ω	680 mA
LRW0402WJ8N7GG001T	8.7 nH	±0.2 nH, ±5%, ±10%	18	60	83	4.1 GHz	0.200 Ω	480 mA
LRW0402WJ9N0GG001T	9.0 nH	±0.2 nH, ±5%, ±10%	22	60	83	4.2 GHz	0.104 Ω	680 mA
LRW0402WJ9N5GG001T	9.5 nH	±0.2 nH, ±5%, ±10%	18	55	76	4.0 GHz	0.200 Ω	680 mA
LRW0402WJ10NGG001T	10.0 nH	±2%, ±5%, ±10%	21	56	76	3.9 GHz	0.195 Ω	480 mA
LRW0402WJ11NGG001T	11.0 nH	±2%, ±5%, ±10%	24	61	86	3.7 GHz	0.120 Ω	640 mA
LRW0402WJ12NGG001T	12.0 nH	±2%, ±5%, ±10%	24	58	77	3.6 GHz	0.120 Ω	640 mA
LRW0402WJ13NGG001T	13.0 nH	±2%, ±5%, ±10%	24	60	77	3.5 GHz	0.210 Ω	560 mA
LRW0402WJ15NGG001T	15.0 nH	±2%, ±5%, ±10%	24	61	86	3.3 GHz	0.172 Ω	560 mA
LRW0402WJ16NGG001T	16.0 nH	±2%, ±5%, ±10%	24	58	77	3.1 GHz	0.220 Ω	560 mA
LRW0402WJ18NGG001T	18.0 nH	±2%, ±5%, ±10%	24	58	77	3.1 GHz	0.230 Ω	420 mA
LRW0402WJ19NGG001T	19.0 nH	±2%, ±5%, ±10%	24	58	77	3.0 GHz	0.202 Ω	480 mA
LRW0402WJ20NGG001T	20.0 nH	±2%, ±5%, ±10%	24	54	74	3.0 GHz	0.250 Ω	420 mA
LRW0402WJ22NGG001T	22.0 nH	±2%, ±5%, ±10%	24	54	73	2.7 GHz	0.300 Ω	400 mA
LRW0402WJ23NGG001T	23.0 nH	±2%, ±5%, ±10%	24	55	73	2.7 GHz	0.214 Ω	400 mA
LRW0402WJ24NGG001T	24.0 nH	±2%, ±5%, ±10%	24	54	74	2.7 GHz	0.300 Ω	400 mA
LRW0402WJ27NGG001T	27.0 nH	±2%, ±5%, ±10%	24	55	75	2.5 GHz	0.298 Ω	400 mA
LRW0402WJ30NGG001T	30.0 nH	±2%, ±5%, ±10%	24	52	64	2.3 GHz	0.300 Ω	400 mA



RF Inductors

WireWound Inductors - 0603 Selection Chart

Part Number (Standard Tolerances)	Inductance @ 250MHz	L/Q Test Frequency	Available Tolerances @ 250MHz	Q (min.) @ L/Q Freq.	SRF (min.)	DC Resistance (max.)	Rated Current (max.)
LRW0603WS1N6GG001E	1.6 nH	250MHz	±0.2 nH, ±0.3 nH	14	7.0GHz	.080 Ω	700 mA
LRW0603WS1N8GG001E	1.8 nH	250MHz	±0.2 nH, ±0.3 nH	16	6.9GHz	.080 Ω	700 mA
LRW0603WS2N0GG001E	2.0 nH	250MHz	±0.2 nH, ±0.3 nH	16	6.9GHz	.080 Ω	700 mA
LRW0603WS3N3GG001E	3.3 nH	250MHz	±0.2 nH, ±0.3 nH	17	6.1GHz	.080 Ω	700 mA
LRW0603WS3N6GG001E	3.6 nH	250MHz	±0.2 nH, ±0.3 nH	20	6.0GHz	.080 Ω	700 mA
LRW0603WS3N6GG001E	3.9 nH	250MHz	±0.2 nH, ±0.3 nH	22	5.9GHz	.080 Ω	700 mA
LRW0603WS4N3GG001E	4.3 nH	250MHz	±0.2 nH, ±0.3 nH	22	5.8GHz	.060 Ω	700 mA
LRW0603WS4N7GG001E	4.7 nH	250MHz	±0.2 nH, ±0.3 nH	20	5.8GHz	.110 Ω	700 mA
LRW0603WJ5N1GG001E	5.1 nH	250MHz	±0.2 nH, ±5%, ±10%	18	5.4GHz	.110 Ω	700 mA
LRW0603WJ5N6GG001E	5.6 nH	250MHz	±0.2 nH, ±5%, ±10%	16	5.0GHz	.110 Ω	700 mA
LRW0603WJ6N8GG001E	6.8 nH	250MHz	±0.2 nH, ±5%, ±10%	30	4.6GHz	.110 Ω	700 mA
LRW0603WJ7R5GG001E	7.5 nH	250MHz	±0.2 nH, ±5%, ±10%	30	4.7GHz	.110 Ω	700 mA
LRW0603WJ8N2GG001E	8.2 nH	250MHz	±0.2 nH, ±5%, ±10%	30	4.8GHz	.110 Ω	700 mA
LRW0603WJ8N7GG001E	8.7 nH	250MHz	±0.2 nH, ±5%, ±10%	31	4.6GHz	.120 Ω	700 mA
LRW0603WJ10NGG001E	10.0 nH	250MHz	±2%, ±5%, ±10%	33	4.0GHz	.130 Ω	700 mA
LRW0603WJ11NGG001E	11.0 nH	250MHz	±2%, ±5%, ±10%	35	4.0GHz	.086 Ω	700 mA
LRW0603WJ12NGG001E	12.0 nH	250MHz	±2%, ±5%, ±10%	35	4.0GHz	.130 Ω	700 mA
LRW0603WJ15NGG001E	15.0 nH	250MHz	±2%, ±5%, ±10%	35	3.1GHz	.170 Ω	700 mA
LRW0603WJ18NGG001E	18.0 nH	250MHz	±2%, ±5%, ±10%	38	3.0GHz	.170 Ω	700 mA
LRW0603WJ22NGG001E	22.0 nH	250MHz	±2%, ±5%, ±10%	38	3.0GHz	.220 Ω	700 mA
LRW0603WJ27NGG001E	27.0 nH	250MHz	±2%, ±5%, ±10%	40	2.8GHz	.220 Ω	600 mA
LRW0603WJ33NGG001E	33.0 nH	250MHz	±2%, ±5%, ±10%	43	2.3GHz	.220 Ω	600 mA
LRW0603WJ39NGG001E	39.0 nH	250MHz	±2%, ±5%, ±10%	43	2.2GHz	.250 Ω	600 mA
LRW0603WJ47NGG001E	47.0 nH	200MHz	±2%, ±5%, ±10%	40	2.0GHz	.280 Ω	600 mA
LRW0603WJ51NGG001E	51.0 nH	200MHz	±2%, ±5%, ±10%	40	1.9GHz	.300 Ω	600 mA
LRW0603WJ56NGG001E	56.0 nH	200MHz	±2%, ±5%, ±10%	40	1.9GHz	.310 Ω	600 mA
LRW0603WJ68NGG001E	68.0 nH	200MHz	±2%, ±5%, ±10%	40	1.7GHz	.340 Ω	600 mA
LRW0603WJ72NGG001E	72.0 nH	150MHz	±2%, ±5%, ±10%	35	1.7GHz	.490 Ω	400 mA
LRW0603WJ82NGG001E	82.0 nH	150MHz	±2%, ±5%, ±10%	35	1.4GHz	.540 Ω	400 mA
LRW0603WJR10GG001E	100.0 nH	150MHz	±2%, ±5%, ±10%	35	1.0GHz	.630 Ω	400 mA
LRW0603WJR12GG001E	120.0 nH	150MHz	±2%, ±5%, ±10%	35	1.0GHz	.650 Ω	400 mA
LRW0603WJR15GG001E	150.0 nH	150MHz	±2%, ±5%, ±10%	35	1.3GHz	.920 Ω	280 mA
LRW0603WJR18GG001E	180.0 nH	100MHz	±2%, ±5%, ±10%	30	1.0GHz	1.25 Ω	240 mA
LRW0603WJR22GG001E	220.0 nH	100MHz	±2%, ±5%, ±10%	30	1.0GHz	1.70 Ω	200 mA
LRW0603WJR27GG001E	270.0 nH	100MHz	±2%, ±5%, ±10%	30	1.0GHz	1.80 Ω	170 mA
LRW0603WJR33GG001E	330.0 nH	100MHz	±5%, ±10%	25	900MHz	3.60 Ω	150 mA
LRW0603WJR39GG001E	390.0 nH	100MHz	±5%, ±10%	24	750MHz	5.30 Ω	100 mA
LRW0603WJR47GG001E	470.0 nH	100MHz	±5%, ±10%	23	700MHz	5.60 Ω	100 mA



RF Inductors

WireWound Inductors - 0805 Selection Chart

Part Number (Standard Tolerances)	Inductance @ 250MHz	L/Q Test Freq.	Available Tolerances @ 250MHz	Q (min.) @ L/Q Freq.	Q Test Freq.	SRF (min.)	DC Resistance (max.)	Rated Current (max.)
LRW0805WS2N2GG001E	2.2nH	250MHz	±0.2 nH, ±0.3 nH	50	1000MHz	>6000 MHz	0.06 Ω	800 mA
LRW0805WS2N7GG001E	2.7nH	250MHz	±0.2 nH, ±0.3 nH	60	1000MHz	>6000 MHz	0.08 Ω	800 mA
LRW0805WS3N3GG001E	3.3 nH	250MHz	±0.2 nH, ±0.3 nH	60	1000MHz	>6000 MHz	0.08 Ω	600 mA
LRW0805WS3N9GG001E	3.9nH	250MHz	±0.2 nH, ±5%, ±10%	60	1000MHz	>6000 MHz	0.06 Ω	600 mA
LRW0805WS4N7GG001E	4.7 nH	250MHz	±0.2 nH, ±5%, ±10%	60	1000MHz	5800MHz	0.06 Ω	600 mA
LRW0805WS5N6GG001E	5.6 nH	250MHz	±0.2 nH, ±5%, ±10%	60	1000MHz	5800MHz	0.08 Ω	600 mA
LRW0805WS6N8GG001E	6.8 nH	250MHz	±2%, ±5%, ±10%	60	1000MHz	5500MHz	0.06 Ω	600 mA
LRW0805W8N2GG001E	8.2 nH	250MHz	±2%, ±5%, ±10%	60	1000MHz	5500MHz	0.06 Ω	600 mA
LRW0805WJ10NGG001E	10.0 nH	250MHz	±2%, ±5%, ±10%	60	500MHz	4800 MHz	0.08 Ω	600 mA
LRW0805WJ12NGG001E	12.0 nH	250MHz	±2%, ±5%, ±10%	60	500MHz	4100 MHz	0.08 Ω	600 mA
LRW0805WJ15NGG001E	15.0 nH	250MHz	±2%, ±5%, ±10%	60	500MHz	3600 MHz	0.08 Ω	600 mA
LRW0805WJ16NGG001E	16.0 nH	250MHz	±2%, ±5%, ±10%	60	500MHz	3500 MHz	0.08 Ω	600 mA
LRW0805WJ18NGG001E	18.0 nH	250MHz	±2%, ±5%, ±10%	60	500MHz	3400 MHz	0.08 Ω	600 mA
LRW0805WJ20NGG001E	20.0 nH	250MHz	±2%, ±5%, ±10%	60	500MHz	3400 MHz	0.08 Ω	600 mA
LRW0805WJ22NGG001E	22.0 nH	250MHz	±2%, ±5%, ±10%	60	500MHz	3300 MHz	0.10 Ω	600 mA
LRW0805WJ27NGG001E	27.0 nH	250MHz	±2%, ±5%, ±10%	60	500MHz	2600 MHz	0.12 Ω	600 mA
LRW0805WJ33NGG001E	33.0 nH	250MHz	±2%, ±5%, ±10%	60	500MHz	2400 MHz	0.15 Ω	500 mA
LRW0805WJ39NGG001E	39.0 nH	250MHz	±2%, ±5%, ±10%	60	500MHz	2100 MHz	0.18 Ω	500 mA
LRW0805WJ47NGG001E	47.0 nH	200MHz	±2%, ±5%, ±10%	60	500MHz	1700 MHz	0.15 Ω	500 mA
LRW0805WJ56NGG001E	56.0 nH	200MHz	±2%, ±5%, ±10%	60	500MHz	1600 MHz	0.25 Ω	500 mA
LRW0805WJ68NGG001E	68.0 nH	150MHz	±2%, ±5%, ±10%	60	500MHz	1450 MHz	0.27 Ω	500 mA
LRW0805WJ82NGG001E	82.0 nH	150MHz	±2%, ±5%, ±10%	60	500MHz	1350 MHz	0.32 Ω	500 mA
LRW0805WJR10GG001E	100 nH	100MHz	±2%, ±5%, ±10%	57	250MHz	1200 MHz	0.43 Ω	500 mA
LRW0805WJR12GG001E	120 nH	100MHz	±2%, ±5%, ±10%	50	250MHz	1100 MHz	0.48 Ω	500 mA
LRW0805WJR15GG001E	150 nH	100MHz	±2%, ±5%, ±10%	50	250MHz	950 MHz	0.56 Ω	400 mA
LRW0805WJR18GG001E	180 nH	100MHz	±2%, ±5%, ±10%	50	250MHz	900 MHz	0.78 Ω	400 mA
LRW0805WJR22GG001E	220 nH	100MHz	±2%, ±5%, ±10%	50	250MHz	860 MHz	1.00 Ω	400 mA
LRW0805WJR27GG001E	270 nH	100MHz	±2%, ±5%, ±10%	45	250MHz	850 MHz	1.46 Ω	350 mA
LRW0805WJR33GG001E	330 nH	25MHz	±2%, ±5%, ±10%	45	250MHz	800 MHz	1.65 Ω	300 mA
LRW0805WJR39GG001E	390 nH	25MHz	±2%, ±5%, ±10%	45	250MHz	780 MHz	2.20 Ω	210 mA
LRW0805FJR47GV001E	470 nH	25MHz	±5%, ±10%	45	100MHz	375 MHz	0.95 Ω	500 mA
LRW0805FJR56GV001E	560 nH	25MHz	±5%, ±10%	45	100MHz	340 MHz	1.10 Ω	450 mA
LRW0805FJR68GV001E	680 nH	25MHz	±5%, ±10%	35	100MHz	188 MHz	1.20 Ω	400 mA
LRW0805FJR82GV001E	820 nH	8MHz	±5%, ±10%	35	100MHz	210 MHz	1.50 Ω	300 mA
LRW0805FJ1R0GV001E	1000 nH	8MHz	±5%, ±10%	35	50MHz	200 MHz	2.13 Ω	180 mA
LRW0805FJ1R2GV001E	1200 nH	8MHz	±5%, ±10%	15	8MHz	200 MHz	2.38 Ω	150 mA
LRW0805FJ1R5GV001E	1500 nH	8MHz	±5%, ±10%	15	8MHz	200 MHz	2.90 Ω	130 mA
LRW0805FJ1R8GV001E	1800 nH	8MHz	±5%, ±10%	15	8MHz	120 MHz	3.00 Ω	120 mA
LRW0805FJ2R2GV001E	2200 nH	8MHz	±5%, ±10%	15	8MHz	110 MHz	3.10 Ω	110 mA
LRW0805FJ2R7GV001E	2700 nH	8MHz	±5%, ±10%	15	8MHz	100 MHz	3.50 Ω	100 mA
LRW0805FJ3R3GV001E	3300 nH	8MHz	±5%, ±10%	15	8MHz	70 MHz	2.30 Ω	210 mA
LRW0805FJ3R9GV001E	3900 nH	8MHz	±5%, ±10%	15	8MHz	60 MHz	2.50 Ω	200 mA
LRW0805FJ4R7GV001E	4700 nH	8MHz	±5%, ±10%	15	8MHz	50 MHz	2.80 Ω	180 mA
LRW0805FJ5R6GV001E	5600 nH	8MHz	±5%, ±10%	15	8MHz	45 MHz	3.00 Ω	160 mA
LRW0805FJ6R8GV001E	6800 nH	8MHz	±5%, ±10%	15	8MHz	45 MHz	3.20 Ω	130 mA
LRW0805FJ8R2GV001E	8200 nH	8MHz	±5%, ±10%	15	8MHz	40 MHz	3.50 Ω	120 mA
LRW0805FJ10RGV001E	10000 nH	8MHz	±5%, ±10%	10	8MHz	40 MHz	5.00 Ω	80 mA



RF Inductors
WireWound Inductors

RF Characteristics

"Typical"

Q vs Frequency for 0402 Size

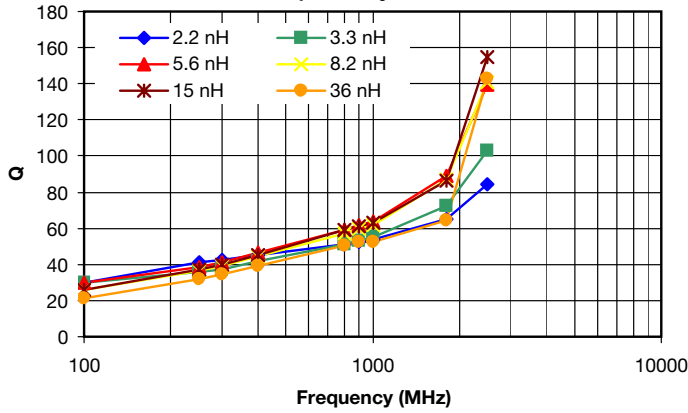

L vs Frequency for 0402 Size

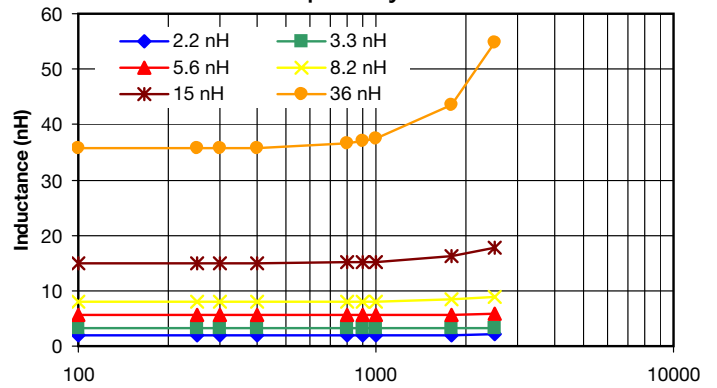

Q vs Frequency for 0603 Size

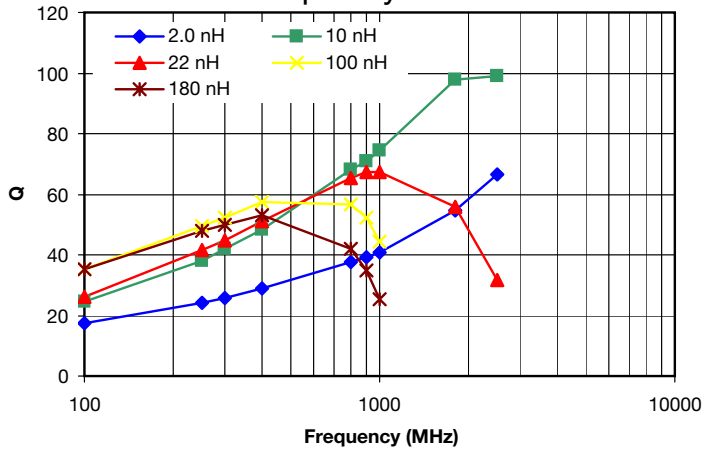

L vs Frequency for 0603 Size

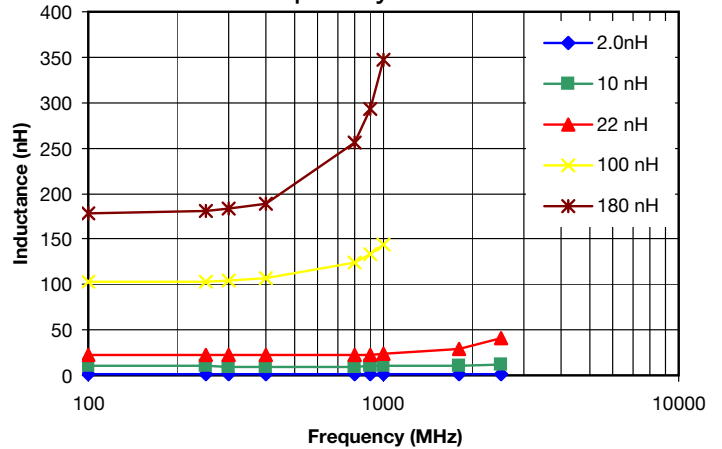

Q vs Frequency for 0805 Size

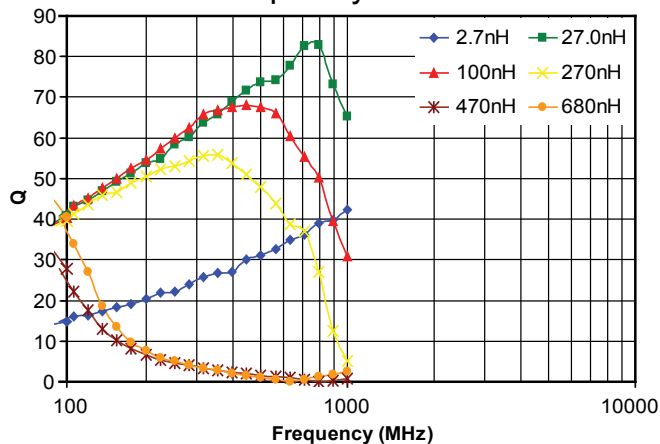

L vs Frequency for 0805 Size

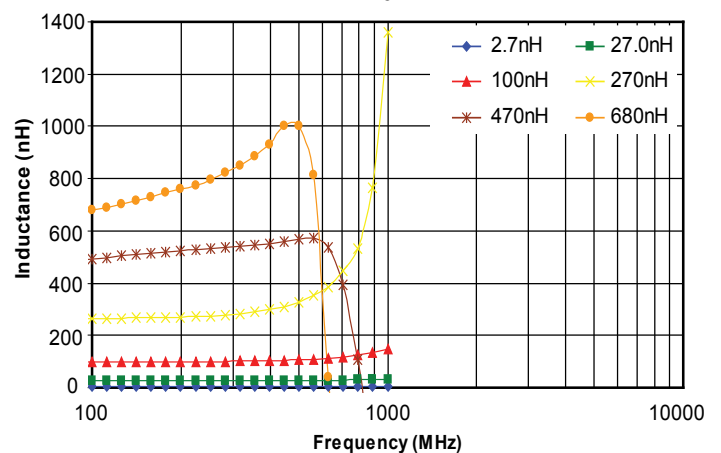

Integrated Passive Components

IPCs by Category

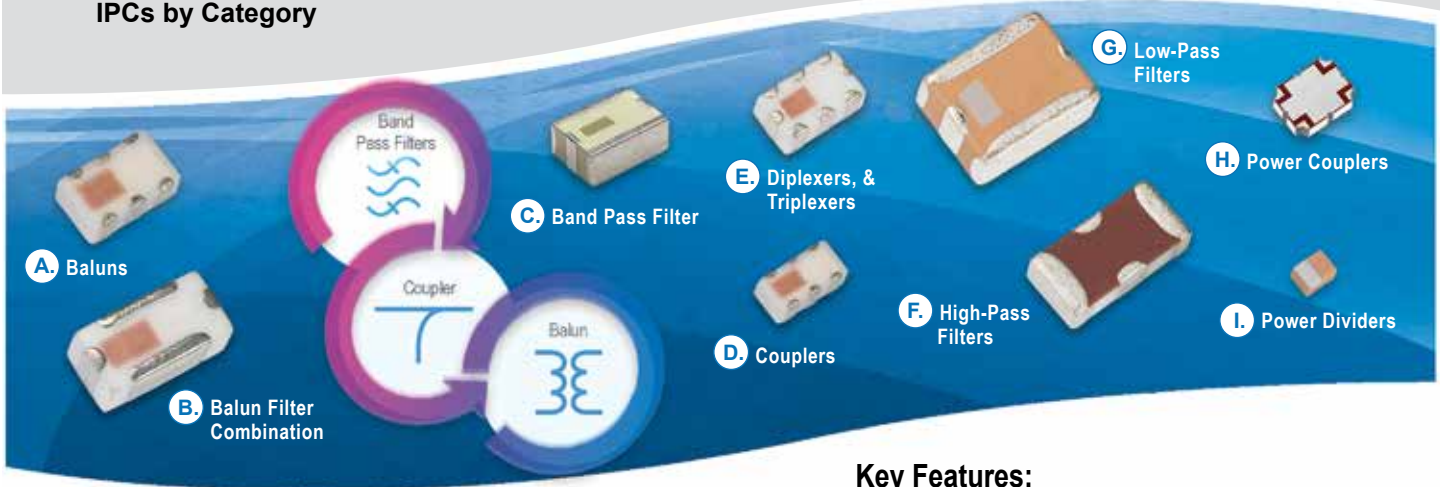

Johanson Technology designs and manufactures a line of small, highly stable and integrated RF ceramic components manufactured with a proprietary LTCC (low temperature co-fired ceramic) process and materials. These components operate and thrive over several RF bands covering IoT, Wi-Fi 6E, Wi-Fi 7, Cellular, DECT, WiMax, all ISM, Bluetooth, 802.11 (a,b & g), and GPS applications.



Key Features:

- RF Bands from 300MHz to 30GHz
- Low Insertion Loss
- Surface Mount, Ultra-low Profiles
- LTCC Based Designs (Low Temperature Co-Fired Ceramics)
- Extremely Temperature Stable
- AEC-Q200 Automotive Qualification (as required)

Application Bands Supported

All ISM Bands (Industrial Scientific, and Medical) 315/433/783/868 915/950/2400MHz	GSM EDGE GPRS	PCS WCDMA	Wireless LAN	Bluetooth	Home RF	Zigbee Operational Bands
GPS	Wi-Fi	Zigbee	UNII	WiMAX 802.16	MiMo	UWB

Chipset Specific Integrated Passive Components Solutions

	 Intel (Infineon)	 Nordic Semiconductor	
 California Eastern Laboratories	 Microchip (Atmel)		
		 Cambridge Silicon Radio (Qualcomm-Atheros)	

Complete RF Front-End Solutions

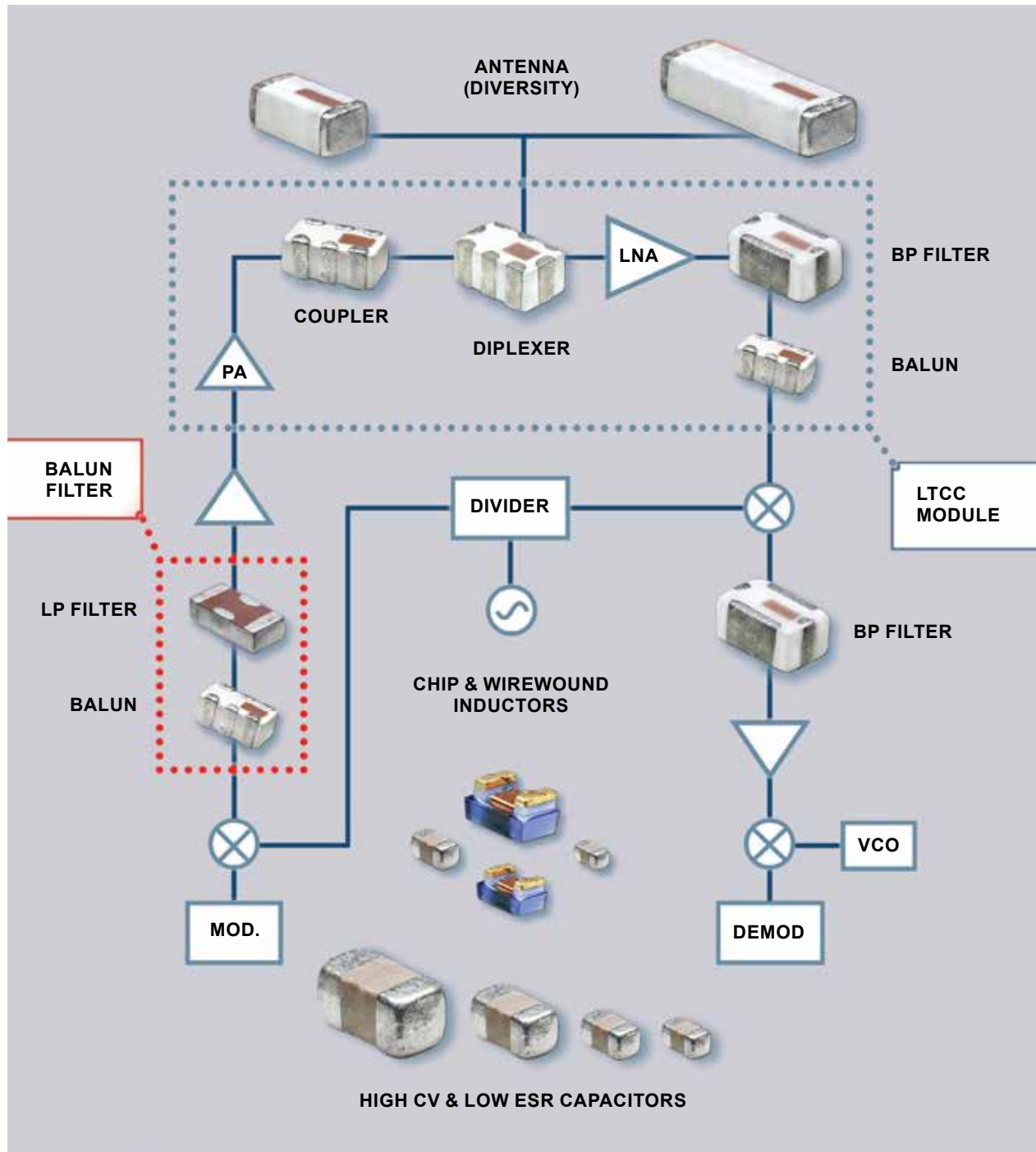

Typical Product Applications

Wi-Fi	UWB	Bluetooth	Zigbee
GPS	WCDMA	GPRS	Custom



Integrated Passive Components (IPCs)

Baluns RF Ceramic Chips

Part Number	Frequency (MHz)	Balanced (Ohms)	Insertion Loss (Max)	Phase Difference	Amplitude Difference (max)
0430BL15A0100001E	400-460	100 (1:2)	1.0	180°±10°	2
0433BM15A0001001E	430-435	Chipset Specific	1.9	180°±10°	0
0433BM41A0019001E	424-444	Chipset Specific Impedance matched to SiLabs Si4455 and Si4460 Chipsets	0.9	180°±10°	0
0465BL15B0100001E	460-470	100 (1:2)	1.0	180°±10°2	
0845BL05A0100001T	729-960	100	0.85 max. (0.95 max. @85°C)	180°±10°	5
0850BM14E0016001T	770-928	Chipset Specific	1.3	180°±17°	3.5
0868BM15C0001001E	863-873	Chipset Specific	2.1	180°±15°	0
0896BL14B0050001T	851-941	50 (1:1)	1.5	180°±10°	1
0896BM15A0001001E	863-928	Chipset Specific	1.5	180°±10°	1.5
0896BM15E0025001E	863,2400 928,2500	Chipset Specific Conj. match to Atmel's AT86RF215, AT86RF215M, AT86RF215IQ chipsets	1.25	180°±10°	2
0900BL15A0100001E	900-1000	100 (1:2)	1.2	180°±10°	2
0900BL15C0050001E	800-1000	50 (1:1)	1.2	180°±10°	2
0900BL15D0050001E	800-1000	50 (1:1)	1.2	180°±10°	2
0900BL18B0100001E	800-1000	100 (1:4)	1.0	180°±10°	2
0900BL18B0200001E	800-1000	200 (1:4)	1.0	180°±10°	2
0900PC15F0030001E	862-928	Chipset Specific Impedance matched to ADF7023, ADF7023-J, ADF7024	1.8	180°±15°	0
0900PC15J0013001E	868-928	Chipset Specific	2.0	180°±15°	0
0915BM15A0001001E	902-928	Chipset Specific	1.0	180°±15°	0
0917BL18B0100001E	889-945	100 (1:2)	1.0	180°±10°	2
10R1BL14A0100001T	9900-11000	100	1.5	180°±8	0.8
1350BL15B0075001E	400-2300	75 (1:1.5)	1.4	180°±10°	2
1600BL15B0050001E	1500-1700	50 (1:1)	1.0	180°±10°	2
1600BL15B0100001E	1500-1700	100 (1:2)	1.0	180°±10°	2
1720BL15A0100001E	625-2815	100 (1:2)	1.5	180°±10°	1
1720BL15A0100002E	625-2815	100	1.5	180°±10°	1
1720BL15B0050001E	625-2815	50 (1:1)	1.5	180°±10°	1
1720BL15B0050002E	625-2815	50 (1:1)	1.5	180°±10°	1
1720BL15B0200001E	625-2815	200 (1:4)	1.5	180°±10°	1
1850BL15B0050001E	1700-2000	50 (1:1)	1.0	180°±10°	2
1850BL15B0100001E	1700-2000	100 (1:2)	1.0	180°±10°	2
1850BL15B0200001E	1700-2000	200 (1:4)	1.0	180°±10°	2



Integrated Passive Components (IPCs)
Baluns RF Ceramic Chips

Part Number	Frequency (MHz)	Balanced (Ohms)	Insertion Loss (Max)	Phase Difference	Amplitude Difference (max)
2100BL15A0100001E	2100-2200	100 (1:2)	1.0	180°±10°	2
2450BL05A0100001T	2300-2690	100 (1:2)	0.55	180°±10°	3
2450BL07A0050001T	2400-2500	50 (1:1)	1.0	180°±10°	2
2450BL07A0100001T	2400-2500	100 (1:2)	1.3	180°±10°	2
2450BL14C0050001T	2400-2500	50 (1:1)	1.2	180°±10°	2
2450BL14C0100001T	2400-250	100 (1:2)	1.2	180°±10°	2
2450BL14C0200001T	2400-2500	200 (1:4)	1.3	180°±10°	2
2450BL15B0050001E	2400-2500	50 (1:1)	1.0	180°±10°	2
2450BL15B0100001E	2400-2500	100 (1:2)	1.0	180°±10°	2
2450BL15B0200001E	2400-2500	200 (1:4)	1.0	180°±10°	2
2450BL15K0100001E	2400-2500	100 (1:2)	1.0	180°±10°	2
2450BM08B0003001T	2400-2500	Chipset Specific Impedance matched to Nordic Semi nRF51822-CEAA, nRF51822-CDAB, nRF51822-CFAC, nRF51422-CEAA, nRF51422-CDAB, & nRF51422-CFAC chipsets	1.0	180°±10°	0
2450BM14A0002001T	2400-2500	Chipset Specific Impedance match to nRF24L01 nRF24L01+ nRF24LE1 nRF24LU1 nRF24AP2 nRF8001 Chipsets	2.0	160°±15°	0
2450BM14E0003001T	2400-2500	Chipset Specific Impedance matched to Nordic Semi nRF51822-QFAA and nRF51422-QFAA chipsets	0.9	150°±15°	0
2450BM14E0003002T	2400-2500	Chipset Specific Impedance matched to Nordic Semi : NRF51824-QFAA, NRF51824-QFAA-R, nRF51824-QFAA-R7, & nRF51824-QFAA-T chipsets	0.9	150°±15°	0
2450BM14E0007001T	2400-2500	Chipset Specific Conjugate match to ADI ADF7241 & ADF7242	1.5	180°±10°	0
2450BM14G0011001T	2400-2500	Chipset Specific	1.5	180°±10°	0
2450BM14G0011002T	2400-2500	Chipset Specific	1.5	180°±10°	2
2450BM15A0001001E	2400-2500	Chipset Specific	1.0	180°±15°	0
2450BM15A0002001E	2400-2500	Chipset Specific	1.5	180°±10°	0
2450BM15A0015001E	2400-2500	Chipset Specific Impedance match to AT86RF232, AT86RF233, ATmega64/128/256RFR2, Zigbit 256RFR2, Zigbit RF233, ZigBit RF233+FEM, Extension RF233, USB RF233, SAM R21E, and SAM R21G	1.5	180°±10°	0



Integrated Passive Components (IPCs)
Baluns RF Ceramic Chips

Part Number	Frequency (MHz)	Balanced (Ohms)	Insertion Loss (Max)	Phase Difference	Amplitude Difference (max)
2450BM15B0002001E	2400-2500	Chipset Specific	1.5	180°±15°	0
2450BM15B0003001E	2400-2500	Chipset Specific	2.2	180°±12°	0
2450BM15B0009001E	2400-2500	Chipset Specific Impedance match to ZIC2410 chipset	1.5	180°±10°	0
2450BM15B0026001E	2400-2500	Chipset Specific Impedance matched for NXP KW40, KW30, and KW20 Chipsets	1.0	180°±10°	0
2450FB15K0002001E	2400-2500	Chipset Specific Impedance match to CSR BC03/BC04 (16-j40)	3.0	180°±10°	0
2450FB15K0005001E	2400-2500	Chipset Specific Impedance match to CSR BC03/04/05	3.5	180°±10°	0
2450FB15L0001001E	2400-2500	Chipset Specific Impedance match to AT86R	1.5	180°±10°	0
2450FB15M0001001E	2400-2500	Chipset Specific Impedance match to MTK and BC05 chipsets	3.0	180°±15°	0
2500BL14M0050001T	2300-2700	50 (1:1)	1.2	180°±15°	1.5
2500BL14M0100001T	2300-2700	100 (1:2)	1.2	180°±15°	2
3400BL15A0100001E	1.8-5.0	100	0.81 typ. / 1.0 max.	180°± 8 typ. / 180°± 12	0.8 typ. / 1.3 max.
3600BL14M0050001T	3300-3900	50 (1:1)	1.2	180°±15°	2
3600BL14M0100001T	3300-3900	50 (1:2)	1.2	180°±15°	2
3700BL15B0100001E	3400-4000	100 (1:2)	1.0	180°±20°	1
3700BL15B0100002E	3400-4000	100 (1:2)	1.0	180°±20°	1
3700BL15B0200001E	3400-4000	200 (1:4)	1.2	180°±20°	1
3700BL15C0050001E	3400-4000	50 (1:1)	1.2	180°±25°	2
4400BL15A0050001E	2800-6000	50 (1:1)	1.5	180°±12°	2
4400BL15A0100001E	2800-6000	100 (1:2)	1.5	180°±12°	2
5400BL14A0050001T	4800-5950	50	1.1	180±10°	0
5400BL14B0100001T	4900-5875	100 (1:2)	1.0	180°±10°	2
5400BL15B0100001T	4900-5900	50 (1:1)	1.0	180°±10°	2
5400BL15B0100001E	4900-5900	100 (1:2)	1.0	180°±10°	2
5400BL15B0200001E	4900-5875	200 (1:4)	1.0	180°±10°	2
5400BL15K0050001E	4900-5875	50 (1:1)	1.2	180°±10°	2
5425BL07A0200001T	4900-5950	200 (1:4)	1.2	180°±15°	2
5500BL15U0100001E	3000-8000	100 (1:2)	1.8	180°±20°	2
6750BL14A0050001T	4900-8500	50 (1:1)	0.7 typ. (1.5 max.)	180°±13°	1.5
6750BL14A0100001T	4900-8500	100 (1:2)	0.7 typ. (1.5 max.)	180°±13°	1.5



Integrated Passive Components (IPCs)

Baluns Filter Combinations - RF Ceramic Chips

Part Number	Frequency (MHz)	Balanced (Ohms Ω)	Insertion Loss (Max)	Attenuation (dB min.)	Phase Difference	Case Size
0783FB15A0100001E	779-787	50/100	1.5	30dB min. @ 2Fo 30dB min. @ 3Fo 30dB min. @ 4Fo	$180^\circ \pm 15$	0805
0896FB15A0100001E	863-928	50/100	1.5	30 dB min. @ 1726~1856 MHz 30 dB min. @ 2589~2784 MHz 30 dB min. @ 3452~3712 MHz	$180^\circ \pm 15$	0805
0900PC15A0036001E	862-928 2400-2500	50	1.8 typ (2.0 max.) 1.3 typ (1.6 max.)	17 min. @ 1736-1856 40 min. @ 2604-2784 20 min. @ 4800-5000 40 min. @ 7200-7500	$180^\circ \pm 15$	0805
2345FB39A0050001E	2300-2390	50/50	3.2	30 min. @ 766~797 MHz 20 min. @ 1532~1594 MHz 12 min. @ 2110~2170 MHz 29 min. @ 3066~3186 MHz 28 min. @ 3833~3983 MHz	$180^\circ \pm 10$	1008
2450FB15A0100001E	2400-2500	50/50	1.5	20 min. @ 4800~5000 MHz 20 min. @ 7200~7500 MHz 20 min. @ 4800~5000 MHz	$180^\circ \pm 10$	0805
2450FB15A0050001E	2400-2500	50/50	1.5	28 min. @ 2 x Fo 20 min. @ 3 x Fo	$180^\circ \pm 10$	0805
2450FB15C0050001E	2400-2500	50/50	1.5	28 min. @ 2 x Fo 20 min. @ 3 x Fo	$180^\circ \pm 10$	0805
2450FB39B0100001E	2400-2500	50/100	2.0	35 min. @ 880~960 MHz 30 min. @ 1710~1910 MHz 30 min. @ 4800~5000 MHz 25 min. @ 7200~7500 MHz	$180^\circ \pm 10$	1008
2500FB16A0400001E	2300-2690	50 Ω + 2.4nH	3.8	15 min. @ DC~800 MHz 35 min. @ 800~960 MHz 15 min. @ 960~1700 MHz 30 min. @ 1700~1900 MHz 25 min. @ 1900~1980 MHz	$180^\circ \pm 10^\circ$	0806
3500FB39A0050001E	3400-3600	50/50	2.9	35 min. @ 680~720MHz 35 min. @ 1088~1152MHz 45 min. @ 2040~2160MHz 32 min. @ 2720~2880MHz 15 min. @ 4080~4320MHz	$180^\circ \pm 12$	1008
5400FB15A0100001E	4900-5875	50/50	2.9	30 min. @ 3500MHz	$180^\circ \pm 15$	0805



Integrated Passive Components (IPCs)

Band Pass Filters

Part Number	Frequency (MHz)	Insertion Loss (dB)	Attenuation (dB Min)	Case Size (EIA)
1200BP44A0575001E	950-1525	2.8	25 dB @ 100-480 25 dB @ 1900-3050	1812
1400BP41A0550001E	1125-1675	1.8 max. @ 25°C 2.0 max. @ -40-85°C	35 min. @ 5-864 MHz 34 min. @ 865-1002 MHz 32 min. @ 2300-3000 MHz	1210
1810BP07B0200001T	1700-1910	2.0	20 dB @ 855-955 (Prelim.) 10 dB @ 2565-2865 (Prelim.)	0402
1905BP18A0050001E	1880-1930	1.65	20 dB @ 100-1500 MHz 15 dB @ 2300-6000 MHz 25 dB @ 1250-1290 MHz 30 dB @ 2400-2500 MHz 25 dB @ 2500-2570 MHz	1206
1988BP41A0600001E	1680-2295	2.0 max. @ 25°C 2.5 max. @ -40 to +105°C	30 min. @ 0-1400 MHz 30 min. @ 2620-2705 MHz 40 min. @ 2705-2740 MHz 35 min. @ 2740-3115 MHz 40 min. @ 3115-3235 MHz	1210
2150BP39A0100001E	2100-2200	3.2 max.	18 min. @ 1950 MHz 18 min. @ 2360 MHz	1008
2442BP08A0080001T	2402-2482	1.9dB (Typ.) 2.4dB (Max.)	28 dB Typ. @ 699-1700 MHz 26 dB Typ. @ 1700-2200 MHz 40 dB Typ. @ 2300-2370 MHz	0403
2450BP07A0100001T	2400-2500	2.5	25 dB @ 824-960 MHz 25 dB @ 1710-1910 MHz 25 dB @ 4800-5000 MHz 15 dB @ 7200-7500 MHz	0402
2450BP08A0100001T	2400-2500	1.0 max. @ 25°C 1.2 max. @ 105°C	15 min. @ 50-960 MHz 10 min. @ 1710-1990 MHz 15 min. @ 3600 MHz 30 min. @ 4800-5000 MHz 25 min. @ 5000-7200 MHz	0504
2450BP14D0100001T	2400-2500	1.7	30 dB @ 880-915 MHz 30 dB @ 1710-1785 MHz 25 dB @ 1850-1910 MHz 25 dB @ 4800-5000 MHz 15 dB @ 7200-7500 MHz	0603
2450BP14E0100001T	2400-2500	2.5	35 dB @ 824-960 MHz 38 dB @ 1710-1910 MHz 25 dB @ 4800-5000 MHz 20 dB @ 7200-7500 MHz	0603
2450BP14F0100001T	2400-2500	2.5 max. (25°C) 2.8 max. (-40 to +85)	40 dB @ 880-915 MHz 40 dB @ 1710-1850 MHz 40 dB @ 1850-1910 MHz 40 dB @ 1920-1990 MHz 25 dB @ 2100-2170 MHz	0603
2450BP14G0100001T	2400-2500	2.0 max. (-40 to +85°C)	40 dB @ 824-960 MHz 27 dB @ 1710-1990 MHz 15 dB @ 2110 MHz 40 dB @ 4800-5000 MHz 25 dB @ 7200-7500 MHz	0603



Integrated Passive Components (IPCs)

Band Pass Filters

Part Number	Frequency (MHz)	Insertion Loss (dB)	Attenuation (dB Min.)	Case Size (EIA)
2450BP15B0100001E	2400-2500	2.2	25 @ 1200-1300 MHz 10 @ 2000 MHz 12 @ 3000 MHz 30 @ 3600-3800 MHz 34 @ 4800-5000 MHz	0805
2450BP15C0100001E	2400-2500	2.2	30 dB @ 1200-1300 MHz 15 dB @ 2000 MHz 25 dB @ 3000 MHz 20 dB @ 3600-3800 MHz 20 dB @ 4800-5000 MHz	0805
2450BP15F0100001E	2400-2500	2.5	824-960 MHz @ 35 dB 1710-1910 MHz @ 38 dB 4800-5000 MHz @ 25 dB 7200-7500 MHz @ 20 dB	0805
2450BP15H0100001E	2400-2500	1.5 max. @ 25°C 1.8 max. @ -40-85°C	25 dB @ 1200-1300 MHz 10 dB @ 2000 MHz 12dB @ 3000 MHz 30 dB @ 3600-3800 MHz 34 dB @ 4800-5000 MHz	0805
2450BP15Q0100001E	2400-2500	1.8 max. @ 25°C 2.0 max. @ -40-85°C	35 min. @ 824-960 MHz 30 min. @ 1545-1605 MHz 35 min. @ 1710-1990 MHz 30 min. @ 2170 MHz 30 min. @ 4800-5000 MHz	0805
2450BP18C0100C001E	2400-2500	2.5	40 dB @ 900-928 MHz 30 dB @ 1.2-1.8 GHz 25 dB @ 2.1 GHz 35 dB @ 4.8-5.0 GHz 40 dB @ 7.2-7.5 GHz	1206
2450BP18C0100E001E	2400-2500	2.5	40 dB @ 1.2-1.8 GHz 25 dB @ 2.1 GHz 35 dB @ 4.8-5.0 GHz 25 dB @ 7.2-7.5 GHz	1206
2450BP39C0100001CE	2400-2500	1.5	30 @ 800-915 MHz 30 @ 1710-1785 MHz 25 @ 1850-1910 MHz 25 @ 4800-5000 MHz 15 @ 7200-7500 MHz	1008
2450BP39C0100001E	2400-2500	2.5	42 dB @ 1.71-1.99 GHz 30 dB @ 2.1 GHz 30 dB @ 4.8-5.0 GHz	1008
2450BP39D0100B001E	2400-2500	2.5	35 @ 800-915 MHz 18 @ 1710-1785 MHz 12 @ 2100 MHz 35 @ 3200 MHz 22 @ 4800-5000 MHz	1008
2450BP39D100C001E	2400-2500	1.2	30 @ 800-915 MHz 30 @ 1710-1785 MHz 25 @ 1850-1910 MHz 25 @ 4800-5000 MHz 15 @ 7200-7500 MHz	1008



Integrated Passive Components (IPCs)

Band Pass Filters

Part Number	Frequency (MHz)	Insertion Loss (dB)	Attenuation (dB Min.)	Case Size (EIA)
2450BP39D100E001E	2400-2500	1.2	30 @ 880-915 MHz 30 @ 1710-1785 MHz 25 @ 1850-1910 MHz 2 @ 2700 MHz 25 @ 4800-5000 MHz	1008
2450BP39F0100001E	2400-2500	2.4	45 @ 880-915 MHz 48 @ 1710-1990 MHz 20 @ 2110-2170 MHz 30 @ 4800-5000 MHz 36 @ 7200-7500 MHz	1008
2500BP15M0400001E	2300-2700	2.0	15 dB @ 100-1800 MHz 20 dB @ 3400-11700 MHz	0805
2600BP14M0200001T	2500-2700	2.2 dB max. @ 25°C 2.5 dB max. @ -40-85°C	30 dB @ 806-915 MHz 30 dB @ 1710-1785 MHz 30 dB @ 1850-1910 MHz 30 dB @ 1920-1980 MHz 13 dB @ 3300-3900 MHz	0603
28R0BP39A2000001E	27500-29500	1.4 typ. 2.3 max.	22G Hz - 24 GHz @ 5 dB typ. (20dB min.) 32G Hz - 35 GHz @ 28 dB typ. (20dB min.)	1008
28R0BP39A3500001E	26500-30000	1.3 typ. 2.5 max.	DC - 20 GHz @ 31 dB typ. (28dB min.) 20G Hz - 24.5 GHz @ 26 dB typ. (20dB min.) 32.5G Hz-33 GHz @ 27dB typ. (20dB min.) 33G Hz - 40 GHz @ 25 dB typ. (20dB min.)	1008
3350BP39A0500001E	3100-3600	2.0	35 dB @ 500-2000 MHz 30 dB @ 2500 MHz 5 dB @ 2950 MHz 10 dB @ 4000 MHz 28 dB @ 5000 MHz	1008
3600BP14M0600001T	3300-3700	1.8 dB max. @ 25°C 2.0 dB max. @ -40-85°C	30 dB @ 806-915 MHz 30 dB @ 1710-1785 MHz 30 dB @ 1850-1910 MHz 30 dB @ 1920-1980 MHz 31 dB @ 2400-2500 MHz	0603
3600BP15M0600001E	3300-4200	1.7 max.	35 min. @ 600-960 MHz 35 min. @ 1164-1300 MHz 35 min. @ 1476-1511 MHz 40 min. @ 1559-1610 MHz 35 min. @ 1710-1785 MHz	0402
3750BP14A0900001T	3300-4200	2.3 typ. 2.7 max.	44 typ. (40 min.) @ DC - 2170 MHz 41 typ. (30 min.) @ 2300 - 2700 MHz 22 typ. (20 min.) @ 5500 - 5850 MHz	0603
3750BP14D0900001T	3300-4200	1.35 typ. 1.7 max.	47 typ. (35 min.) @ 100 - 2570 MHz 49 typ. (40 min.) @ 2170 MHz 28 typ. (25 min.) @ 2620 - 2690 MHz 26 typ. (20 min.) @ 5150 - 5950 MHz 35 typ. (27 min.) @ 6600 - 8400 MHz	0603
3960BP39A1584001E	3168-4752	2.5	30 dB @ 2400-2500 MHz 12 dB @ 5150 MHz 25 dB @ 5950 MHz	1008



Integrated Passive Components (IPCs)

Band Pass Filters

Part Number	Frequency (MHz)	Insertion Loss (dB)	Attenuation (dB Min)	Case Size (EIA)
4000BP15U1800001E	3168-4752	2.5	30 dB @ 2400-2500 MHz 12 dB @ 5150 MHz 25 dB @ 5950 MHz	1008
4700BP07B0600001T	4400-5000	1.5 max.	35 min. @ 600-960 MHz 35 min. @ 1164-1300 MHz 35 min. @ 1476-1511 MHz 35 min. @ 1559-1610 MHz 35 min. @ 1805-2200 MHz	0402
4700BP14A0600001T	4400-5000	1.9 typ. 2.5 max.	42 typ. (38 min.) @ DC - 2170 MHz 42 typ. (30 min.) @ 2300 - 2700 MHz 23 typ. (20 min.) @ 5500 - 5850 MHz	0603
4700BP14C0600001T	4400-5000	1.15 typ. 1.5 max.	47 typ. (35 min.) @ 400 - 915 MHz 43 typ. (30 min.) @ 925 - 2485 MHz 31 typ. (20 min.) @ 2485 - 3600 MHz 22 typ. (7 min.) @ 5850 - 6100 MHz 21 typ. (15 min.) @ 6100 - 6980 MHz	0603
4700BP15A0600001E	4400-5000	0.7 typ. 0.9 max.	36 typ. (30 min.) @ 500 - 2690 MHz 18 typ. (15 min.) @ 2700 - 3800 MHz 30 typ. (15 min.) @ 8800 - 10000 MHz 30 typ. (15 min.) @ 13200 - 15000 MHz	0805
5130BP18U4060001E	3100-7160	1.6	25 dB @ 824 - 960 MHz 25 dB @ 1710-1990 MHz 15 dB @ 2400 - 2500 MHz 20 dB @ 10100-10600 MHz	1206
5235BP44A0180001E	5170-5330	2.2 typ. 2.5 max.	30 min. @ 2400-2500 MHz 40 min. @ 5490-5835 MHz 25 min. @ 10340-10660 MHz	1812
5400BP14A0950001T	4900-5850	1.5 max. @ 25°C 1.7 max. @ -40°C to 85°C	33 dB @ 100-2170 MHz 29 dB @ 2170-2500 MHz 32 dB @ 9800-12000 MHz	0603
5425BP15A1050001E	4900-5950	2.0	40 dB @ 1280-3300 MHz 25 dB @ 3300-4000 MHz 7 dB @ 4375-4465 MHz 14 dB @ 7300-8930 MHz 25 dB @ 9800-1190 MHz	0805
5497BP46A0655001E	5170-5825	.1dB Typ. / 2.6 Max. @ 5170-5835 MHz (80 MHz BW) 1.5 Typ. / 2.0 Max. @ 5170-5835 MHz (160 MHz BW)/p>	60 Typ. / 45 Min. @ 450 - 1900 MHz 58 Typ. / 40 Min. @ 1900 - 2690 MHz 38 Typ. / 30 Min. @ 3300 - 4400 MHz 50 Typ. / 45 Min. @ 5945 - 7065 MHz (80/160 MHz) 70 Typ. / 55 Min. @ 7065 - 7125 MHz (80/160 MHz)	2112
5500BP41A0665001E	5170-5835	1.7 typ. 2.5 max.	34 typ. (25 min.) @ 2.4 - 2.5 GHz 32 typ. (30 min.) @ 6.095 - 7.125 GHz 35 typ. (20 min.) @ 10.34 - 11.67 GHz	1210
5500BP44A0700001E	5170-5815 5815-5825 5825-5835 5835-5850	2.8 max. 3.0 max. 3.1 max. 3.3 max.	30 min. @ 30-1700 MHz 30 min. @ 1727-1935 MHz 30 min. @ 2400-2500 MHz 15 min. @ 3453-3870 MHz 4 min. @ 5935 MHz	1812
5515BP15B0725001E	5150-5875	1.5	30 @ 3500 MHz 25 @ 9800-11840 MHz 5 @ 14700-17760 MHz	0805



Integrated Passive Components (IPCs)

Band Pass Filters

Part Number	Frequency (MHz)	Insertion Loss (dB)	Attenuation (dB Min)	Case Size (EIA)
5515BP15B0975001E	4900-5875	1.5	30 dB @ 3500 MHz 25 dB @ 9800 - 11840 MHz 5 dB @ 14700 - 17760 MHz	0805
5515BP15B0975001E	4900-5875	1.5	30 dB @ 3500 MHz 25 dB @ 9800-11840 MHz 5 dB @ 14700-17760 MHz	0805
5515BP15C0725001E	5150-5875	2.5	30 dB @ 500-4000 MHz 20 dB @ 4600 MHz 15 dB @ 10.3-11.8 GHz	0805
5515BP15C0975001E	4900-5875	1.8	30 dB @ 500-4000 MHz 20 dB @ 4200 MHz 15 dB @ 9800-11750 MHz	0805
5515BP15C1020001E	4900-5920	1.5	30dB @ 3500MHz 25dB @ 9800 - 11840MHz 5dB @ 14700 - 17760MHz	0805
5525BP15B0750001E	5150-5900	3.5	35 min. @ 4000 MHz 35 min. @ 4500 MHz 40 min. @ 4600 MHz	0805
5532BP44A0725001E	5170-5815 5815-5825 5825-5835 5835-5850 5850-5895	2.0 max. 2.1 max. 2.2 max. 2.4 max. 2.8 max.	30 min. @ 30-1700 MHz 30 min. @ 1727-1935 MHz 30 min. @ 2400-2500 MHz 15 min. @ 3453-3870 MHz 30 min. @ 6105-6145 MHz	1812
5550BP14A0800001T	5150-5950	0.7 typ. @ 25°C 0.9 max. @ -40°C ~ 85°C	35min. @ 700-2690 MHz 30min. @ 3400-3800 MHz 12min. @ 7250-7800 MHz 20min. @ 10300-11700 MHz	0603
5550BP14A0800002T	5150-5950	0.7 typ. @ 25°C 0.9 max. @ -40°C ~ 85°C	35min. @ 700-2690 MHz 30min. @ 3400-3800 MHz 12min. @ 7250-7800 MHz 20min. @ 10300-11700 MHz	0603
5550BP14B0800001T	5150-5950	0.8 typ. @ 25°C 0.9 max. @ -40°C ~ 85°C	40min. @ 700-2690 MHz 45min. @ 3400-3800 MHz 20min. @ 7250-7800 MHz 20min. @ 10300-11700 MHz	0603
5550BP14D0800001T	5150-5950	0.8 max. @ -40 to +85°C 1.0 max. @ +85 to +105°C	40 dB @ 700~2690 MHz 45 dB @ 3400~3800 MHz 20 dB @ 6900 MHz 20 dB @ 7250~7800 MHz 20 dB @ 10300~11700 MHz	0603
5550BP14E0800001T	5150-5950	0.5 Typ. 0.6 max. @ 85°C 0.8 max. @ 105°C	35 Min. @ 2400 - 2500 MHz 30 Min. @ 10300 - 11900 MHz 25 Min. @ 15450 - 17850 MHz	0803
5697BP44A0360001E	5490-5835	2.2 typ. 2.5 max.	30 min. @ 2400-2500 MHz 40 min. @ 5170-5330 MHz 25 min. @ 10980-11670 MHz	1812



Integrated Passive Components (IPCs)

Band Pass Filters

Part Number	Frequency (MHz)	Insertion Loss (dB)	Attenuation (dB Min)	Case Size (EIA)
6100BP14A1955001T	5170-7125	0.9 max	40 min. @ 2400 - 2500 MHz 30 min. @ 10340 - 14250 MHz 30 min. @ 15510 - 21375 MHz	0603
6300BP44A1200001E	5700-6900	2.0 max	37 min. @ DC - 4500 MHz 32 min. @ 4500 - 5000 MHz 14 min. @ 5000 - 5460 MHz 14 min. @ 7250 - 8000 MHz 32 min. @ 8000 - 9000 MHz	1812
6530BP44A1190001E	5925-7125	2.3	35 min. @ 30-1700 MHz 35 min. @ 1982-2370 MHz 35 min. @ 2400-2500 MHz 33 min. @ 3960-4740 MHz 35 min. @ 4500-5150 MHz	1812
6535BP46A1180001E	5945-7125	2.8 Typ. / 3.0 Max. @ 5945-7125 MHz (80 MHz BW) 1.9 Typ. / 2.8 Max. @ 5945-7125 MHz (160 MHz BW)	68 Typ. / 58 Min. @ 10-2000 MHz 60 Typ. / 55 Min. @ 2000-2570 MHz 60 Typ. / 50 Min. @ 2570-3870 MHz 60 Typ. / 55 Min. @ 3870-4400 MHz 50 Typ. / 48 Min. @ 4400-5170 MHz	2112
6610BP41A1030001E	6095-7125	1.5 typ. 2.5 max.	36 typ. (25 min.) @ 2.4-2.5G Hz 32 typ. (30 min.) @ 5.17-5.835 GHz 29 typ. (15 min.) @ 12.19-14.43 GHz	1210
6613BP44A1025001E	6100-7125	2.4 typ. 2.8 max.	35 min. @ 30-1700 MHz 35 min. @ 1980-2370 MHz 35 min. @ 2400-2500 MHz 33 min. @ 3960-4740 MHz 35 min. @ 4750-5150 MHz	1812
7000BP15A1600001E	6200-7800	1.75 typ. 2.0 max.	30 min. @ 3000-3400 GHz 35 min. @ 3400-3800 GHz 30 min. @ 3800-5600 GHz 5 min. @ 4900-5850 GHz 25 min. @ 8500-16000 GHz	0805
7000BP15A1600002E	6200-7800	1.75 typ. 2.0 max.	30 min. @ 3000-3400 GHz 35 min. @ 3400-3800 GHz 30 min. @ 3800-5600 GHz 5 min. @ 4900-5850 GHz 25 min. @ 8500-16000 GHz	0805
7240BP15B2000001E	6240-8240	1.8 typ. 2.5 max.	35 min. @ DC-5200 MHz 43 min. @ 2400-2500 MHz 19 min. @ 5200-5860 MHz 28 min. @ 9000-9500 MHz 32 min. @ 9500-18000 MHz	0805
7240BP15B2000002E	6240-8240	1.8 typ. 2.5 max.	35 min. @ DC-5200 MHz 43 min. @ 2400-2500 MHz 19 min. @ 5200-5860 MHz 28 min. @ 9000-9500 MHz 32 min. @ 9500-18000 MHz	0805



Integrated Passive Components (IPCs)

Couplers

Part Number	Frequency (MHz)	Insertion Loss (dB)	Coupling	Attenuation (dB Min)
0880CH15A0060001E	850-910	3.3 ± 0.5	-	-
0898CP14C0035001T	880-915	0.35	17.0 ± 1.0	-
0910CF15B0100001E	860-960	1.2	10 ± 1.0	27 dB @ 2x Fo 30 dB @ 3x Fo 30 dB @ 4x Fo 30 dB @ 5x Fo
1575CH15A0030001E	1560-1590	3.3 ± 0.5	-	-
1585CH15A0070001E	1550-1620	3.3 ± 0.5	-	-
1950CH15A0100001E	1900-2000	3.3 ± 0.5	-	-
2450CH15A0100001E	2400-2500	3.3 ± 0.5	-	-
2450CP05A5400001T	2400-2500 4900-5850	0.5	19 ± 1.5 12.5 ± 1.5	20
2450CP14B0100001T	2400-2500	1.0	17.65 ± 1.0	-
5300CF15A0950001E	4900-5850	0.8	15.0 ± 1.0	20 dB @ 2 x Fo
5300CF15A0950002E	4900-5850	0.8	15.0 ± 1.0	20 dB @ 2 x Fo



Integrated Passive Components (IPCs)

Diplexers, & Triplexers RF Ceramic Chips

Part Number	Frequency (MHz)	Insertion Loss (db Typical or Max.)	Attenuation	Case Size
0500DP44A1215001E	950-1450 200-750 1650-215	3.6 3.9 2.0 2.3 3.5 3.8	30.0 min. @ 200-750 MHz 30.0 min. @ 1650-2150 MHz 30.0 min. @ 950-1450 MHz	1812
0790DP15A2205001E	617-960 1710-2700	0.5 max.	30 min. @ 1710-2170 MHz 30 min. @ 2170-2400 MHz 35 min. @ 2400-2700 MHz	0805
0859DP18A1920001E	842-894 1850-1990	0.75 0.55	20db min.	1206
0900DP15A2450001E	863-960 2400-2500	0.57 0.65	27.5 typ. / 25 min. @1726-1920 MHz 23 typ. / 17 min. @2589-2880 MHz 14 typ. / 9 min. @3452-3840 MHz	0805
0967DP18A1795001E	824-894 1850-1990		20 db min.	1206
1175DP41A1925001E	900-1450 900-2200	1.65 1.68	33 dB Typ @ 1650 - 2200 MHz	1210
1175DP41B1925001E	900-1450 1650-2200	2.5 1.0	30 min. @ 824~915 MHz 30 min. @ 1545~1605 MHz 30 min. @ 1710~1910 MHz 22 min. @ 2170 MHz 35 min. @ 4800~5000MHz 30 min. @ 7200~7500 MHz	1210
1407DP15A2450001E	824-960 1710-1880 1900-1990 2400-2500	0.6 1.0 1.5 2.0	15 min. @ 2400-2500 MHz	0805
1590TP15A5500002E	1560-1606 2400-2500 4900-5950	0.9 1.1 1.0	15 min. @ 2400 ~ 2500 MHz 20 min. @ 4900 ~ 5950 MHz 25 min. @ 1560 ~ 1606 MHz 20 min. @ 4900 ~ 5950 MHz 20 min. @ 1560 ~ 1606 MHz	0805
1600DP14B2450001T	1550-1580 1594-1610 2400-2500 4900-6000	0.47dB typ. (0.6 max.) 0.54 typ. (0.7 max.) 0.57dB typ. (0.7 max.) 0.43 typ. (0.6 max.)	12 min. @ 2400-2500 MHz 12 min. @ 4900-6000 MHz 20 min. @ 1550 - 1610 MHz	-
2100DP39A2600001E	617-960 1427-1661 1710-2200 2300-2496 2496-2700 3300-3400 3400-3600 3600-3800 5150-5925 1.658 / 4.612 GHz Ceramic Chip Diplexer	0.4 max. 0.5 max. 0.6 max. 0.7 max. 1.0 max. 1.5 max. 1.2 max. 0.9 max. 1.0 max.	15 min. @ 3300-3400 MHz 20 min. @ 3400-3800 MHz 25 min. @ 5150-5925 MHz	1008



Integrated Passive Components (IPCs)

Diplexers, & Triplexers RF Ceramic Chips

Part Number	Frequency (MHz)	Insertion Loss (db Typical or Max)		Attenuation	Case Size
2450DP14A6100001T	2400-2500 4900-5100 5150-5950 5950-7150	Low Band 2400-2500 MHz 0.6 typ. (0.8 max. @ 25°C) 0.8 typ. (1.0 max. @ 105°C)	High Band 4900-5100 MHz 1.0 typ. (1.3 max. @ 25°C) 1.2 typ. (1.5 max. @ 105°C)	0.6 typ. (0.8 max. @ 25C) 0.8 typ. (1.0 max. @ 105C)	0603
			5150-5950 MHz 0.8 typ. (1.0 max. @ 25°C) 1.0 typ. (1.2 max. @ 105°C)		
			5950-7150MHz 0.8 typ. (1.0 max. @ 25°C) 1.0 typ. (1.2 max. @ 105°C)		
2450DP14A6100001T	2400-2500 5170-7125		0.6 max. 0.9 max.	2min.@3.3-4.8GHz 33 min.@4.8-5GHz 25 min.@5.17-7.125GHz 25min.@7.2-7.5GHz 27 min.@9.6-10GHz	0603
2450DP14B6100001T	2400-2500 5170-7125		0.6 max. 0.9 max.	2 min. @ 3.3-4.8GHz 33 min. @ 4.8-5GHz 25 min. @ 5.17-7.125GHz 25 min. @ 7.2-7.5GHz 27 min. @ 9.6-10GHz	0603
2450DP14B7200001T	2400-2500 6200-8200		0.7 max. @ 25C 1.0 max. @ -40~105C 1.0 max. @ 25C 1.3 max. @ -40~105C	20 min. @4.8-5.0GHz 20 min. @6.2-8.5GHz	
2450DP14B7200002T	2400-2500 6200-8200		0.7 max. @ 25C 1.0 max. @ -40~105C 1.0 max. @ 25C 1.3 max. @ -40~105C	20 min. @4.8-5.0GHz 20 min. @6.2-8.5GHz	
2450DP14C5400001T	2400-2500 4900-5900		0.8 max. 1.2 max.	18 min. @4.8-6.0GHz 20 min. @7.2-7.5GHz	0603
2450DP14C5400002T	2400-2500 4900-5900		0.8 max. 1.2 max.	18 min. @4.8-6.0GHz 20 min. @7.2-7.5GHz	0603
2450DP14D5400001T	2400-2500 4900-5900		0.5 typ. (0.68 max. @ 25C / 0.88 max. @ -40~125C) 0.55 typ. (0.78 max. @ 25C / 1.10 max. @ -40~125C)	10 min. @ 3.6-3.75GHz 20 min. @ 4.8-5.0GHz 10 min. @ 7.2-7.5GHz 10 min. @ 9.6-10GHz	0603
2450DP14G5400001T	2400-2500 4900-5950		0.58 0.8	25 min. @ 4.8-5.0 GHz	0603
2450DP14Q5400001T	2400-2500 4900-5950		0.64 0.8	45 typ. @2.4-2.5GHz 45 typ. @4.8-5.0GHz 43 typ. @5.0-6.0GHz	0603
2450DP14R5400001T	2400-2500 4900-5950	Low Band 2.4 - 2.5GHz 0.64 typ.(0.8 max. @ 25°C) 0.84 typ.(1.0 max. @ 105°C)	High Band 4.9 - 5.1G Hz 1.08 typ.(1.2 max.@ 25°C) 1.28 typ.(1.4 max.@ 105°C)	50 typ.(40 min.) @4.8-5.0GHz 34 typ.(30 min.) @7.2-7.5GHz	0603
			5.15 - 5.95GHz 0.8 typ. (1.0 max.@ 25°C) 1.0 typ. (1.2 max.@ 105°C)		



Integrated Passive Components (IPCs)

Diplexers, & Triplexers RF Ceramic Chips

Part Number	Frequency (MHz)	Insertion Loss (db Typical or Max)	Attenuation	Case Size
2450DP15A5512001E	400-2500 5150-5875	0.7 0.9	20db min	0805
2450DP15D5400001E	2400-2500 4900-5875	0.7 1.4	20db min. @ 4.8-6.0GHz 20db min. @ 7.2-7.5GHz	0805
2450DP15E5400001E	2400-2500 4900-5875	0.7 1.60	20db min @ 4.8-6.0GHz 17db min @ 1.8-2.5GHz	0805
2450DP15F5400001E	2400-2500 4900-5900	0.7 1.0	18db min @ 4.8-6.0GHz 19db min @ 1.8-2.5GHz	0805
2450DP15K5400001E	2400-2500 4900-5950	0.5 0.65	20db min @ 4.8-6.0GHz 20db min @ 7.2-7.5GHz	0805
2450DP15L5400001E	2400-2500 4900-5950	0.25 typ. (0.5 max.) 0.35 typ. (0.65 max.)	27 typ. (20 min.)@ 4.8-6.0GHz 30 typ. (20 min.)@ 7.2-7.5GHz	0805
2450DP15Q5400001E	2400-2500 4900-5950	0.5 max.(0.25 typ.) 0.65 max.(0.35 typ.)	20dB min. (27 typ.) @4.8-6.0GHz 20dB min.(30 typ.) @7.2-7.5GHz 20dB min.(23 typ.) @ 0.8-2.5GHz 15dB min.(18typ.) @9.8-11.9GHz	085
2450DP39K5400001E	2400-2500 4900-5900	0.85 0.78	25typ/15min @1550-1610MHz 15typ/10min @3105MHz 22typ/20min @4800-4950MHz 24typ/15min @4900-5950MHz	1008
5200DP44A5800001E	5100-5300 5700-5900	1.6 max. 1.6 max.	20 min. @ 5700 - 5900MHz 20 min. @5100 - 5300MHz	1812



Integrated Passive Components (IPCs)

High Pass Filters RF Ceramic Chips

Part Number	Frequency (MHz)	Insertion Loss (Max)	Attenuation	Case Size
1900HP41B0500001E	1650-2150	2.0	27 dB @ 950 - 1450 MHz (Prelim)	1210
1900HP41C0500001E	1650-2150	2.0	27 dB @ 950 - 1450 MHz	1210
2450HP14A0100001T	2450-2500	1.0	9 dB @ 824 - 960 MHz (Prelim.) 20 dB @ 1917 MHz (Prelim)	0603
5400HP05A0950001T	4900-5850	.065	20 dB @ 2450-2500 MHz	0202



Integrated Passive Components (IPCs)

Low Pass Filters RF Ceramic Chips

Part Number	Frequency (MHz)	Insertion Loss (Max)	Attenuation	Case Size
0400LP15A0122001E	312-434	0.9	28dB @ 624-630MHz 30dB @ 800-900MHz 35dB @ 900-950MHz 38dB @ 1575MHz 34dB @ 1700-2100MHz	0805
0400LP15A0122002E	312-434	0.9	28dB @ 624-630MHz 30dB @ 800-900MHz 35dB @ 900-950MHz 38dB @ 1575MHz 34dB @ 1700-2100MHz	0805
0500LP15A0500001E	0-500	0.7	9dB @ 824-960MHz 25dB @ 1.71-1.99MHz 25dB @ 2.4-4.0MHz	0805
0868LP15A0020001E	858-878	0.5	30dB @ 2 x fo 40dB @ 3 x fo	0805
0869LP14A0090001T	824-915	0.6	20dB @ 2 x fo 15dB @ 3 x fo	0603
0900LP15B0063001E	863-960	0.9	50dB@1726-1856MHz (46 min) 59dB@2589-2784MHz (41 min)	0805
0915LP15B0026001E	902-928	0.5	30dB @ 2 x fo 30dB @ 3 x fo	0805
1000LP41B1000001E	5-1002	1.76	37dB@1125MHz (28dB min) 35dB@1126~1675MHz (28 min)	1210
1175LP15A0550001E	900-1450	2.5	25dB @ 1650-2200MHz	0805
1175LP15A0550001E	900-1450	2.5	25dB @ 1650-2200MHz	0805
1200LP41B0500001E	950-1450	2.0	24dB @ 1650-2150MHz	1210
1200LP41C0500001E	950-1450	2.0	24dB @ 1650-2150MHz	1210
1748LP18A0075001E	1710-1785	0.6	30dB @ 3500MHz 20dB @ 5240MHz	1206
1810LP07A0200001T	1710-1910	0.5	20dB @ 2 x fo 20dB @ 3 x fo	0402
1850LP16A0105001E	1805-1910	0.4	30 min. @ 3.61 - 3.82GHz 20 min. @ 5.415-5.73GHz	0806
2025LP15A1225001E	800-1000 1700-1910 2010-2025	0.5 0.8 1.5	26dB@2300~6100MHz (20dB min) 34dB@3700-4100MHz (30dB min) 15dB@6100~8000MHz (10dB min)	0805
2450LP05A0100001T	2400-2500	0.45 max	35 min @ 4800MHz-5000MHz 35 min @ 7200MHz-7500MHz	0202
2450LP07C0100001T	2400-2500	0.4	34dB @ 2 x fo 35dB @ 3 x fo	
2450LP14A0100001T	2400-2500	0.5	25dB @ 2 x fo 18dB @ 3 x fo	0603
2450LP14B0100001T	2400-2500	0.5	35dB @ 2 x fo 25dB @ 3 x fo	0603



Integrated Passive Components (IPCs)

Low Pass Filters RF Ceramic Chips

Part Number	Frequency (MHz)	Insertion Loss (Max)	Attenuation	Case Size
2450LP14B0100001T	2400-2500	0.5	35dB @ 2 x fo 25dB @ 3 x fo	0603
2450LP15A0050001E	2400-2500	0.5	27dB @ 2 x fo 25dB @ 3 x fo	0805
2450LP15B0050001E	2400-2500	0.5	32dB @ 2 x fo 30dB @ 3 x fo 30dB @ 4 x fo	0805
2500LP14A0400001T	2300-2700	0.55	35dB @ 2 x fo 25dB @ 3 x fo	0603
3550LP14A0300001T	3400-3700	0.65	25dB @ 2 x fo 25dB @ 3 x fo	0603
5515LP15A0730001E	5150-5875	0.5	25dB @ 2 x fo 18dB @ 3 x fo	0805



Integrated Passive Components (IPCs)

Power Coupler RF Ceramic Chips

Part Number	Frequency (MHz)	Insertion Loss (Max)	Power Capacity	Case Size
0850HC47A0300001E	700-1000	0.14 max.	300 Max (CW)	2520



Integrated Passive Components (IPCs)

Power Dividers RF Ceramic Chips

Part Number	Frequency (MHz)	Insertion Loss (Max)	Attenuation	Case Size
2450PD05A0100001T	2400-2500	4.0 max. (3.3 typ.)	-	-
2450PD14B0100001T	2400-2500	OUT1 3.4±0.6 OUT2 3.4±0.6	4800-5000 10dB min 7200-7500 15dB min	0603



Planars - Array Caps for EMI Filtering

Johanson Dielectrics is the premier supplier of Planar Capacitor EMI Filter Arrays to the Filtered Connector Industry. Johanson filters exhibit excellent RF performance, as well as high SRF's (Series Resonant Frequency). Planar Capacitors are the fundamental building block for filtered connectors in Aerospace, Biomedical, Military, Satellite, Industrial and Communication electronics

Johanson offers NP0, X7R and MOV (Metal Oxide Varistor) Planar Arrays in standard and custom solutions to fit your needs (1 to 150 pins).

MOV planar arrays can be used singularly to form low pass capacitive filters with the additional benefit of transient voltage protection. When combined together with planar array capacitors, they can form balanced and unbalanced Pi filters with transient voltage protection. The MOV technology enables smaller connectors to be built when compared to other discrete voltage protection component solutions, such as diodes.

We are eager to quote your custom requirements and unique products, in addition to your commercial or Mil-Standard needs.

Key Features:

- Custom Designs & Geometries
- Circular Arrays and Rectangular Arrays
- Widely Used in EMI Filtering Systems
- Offered in NP0, X7R and MOV (Metal Oxide Varistor)

Ordering Information:

Planar filters are all custom designs as are the part numbers. Planars can be built to customer specifications or can be custom designed to fit customer sensor. For custom designs, Johanson Dielectrics requires the following information at minimum:

- Capacitance value and tolerance
- Rated voltage and DWV requirement
- Length and width or OD (if circular)
- ID dimension or pin/contact size of sensor
- Thickness max

Applications		
Connectors	Voltage Multipliers	Custom Applications
Surge Protection	Industrial Control Circuits	

Custom Capacitor Arrays - EMI Filter Products

Custom Capacitors enable a virtually unlimited custom array capability. Any shape, configuration or geometry is possible, and the performance characteristics of our arrays are only limited by the physics of the materials being used, and Johanson Dielectrics is constantly focused on new material development to establish new limits.

Contact us for your unique design requirements.



Planars

Circular, Rectangular & D-Sub-Miniature Arrays

EMI Filter Types Available



Circular Arrays

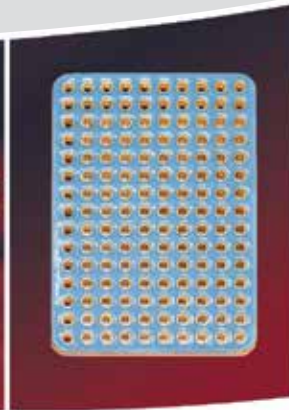

Rectangular Arrays
(ARINC 404/600)



D- Subminiature
Rectangular Arrays

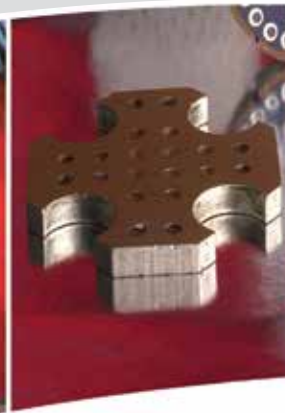

Custom Capacitor Arrays



Discoidal Capacitors

Ask about your specific requirements
(see resource link below)

Circular Arrays - EMI Filter Products

Example Physical Layout	Dielectric Material	Available Capacitance	Working Voltage	DWV Voltage
MIL-1560	X7R, NP0 and Selected MOV	47 pF to 1000 nF	Up to 2,000 VDC	Up to 2,500V VDC
MIL-1554				
MIL-1669				
MIL-1651				
MIL-1698				
MIL-33702				
MIL-AUDIO				

Rectangular Arrays (ARINC 404/600) - EMI Filter Products

Example Physical Layout	Dielectric Material	Available Capacitance	Working Voltage	DWV Voltage
AR-010 Through AR-150	X7R, NP0 and Selected MOV	47 pF to 1000 nF	Up to 2000 VDC	Up to 2,500V VDC

D-Subminiature Rectangular Arrays - EMI Filter Products

Example Physical Layout	Dielectric Material	Available Capacitance	Working Voltage	DWV Voltage
Full size	X7R, NP0 & Selected MOV	47pF - 210nF	≤ 2,400	≤ 3,600
Mini-D		47pF - 100nF	≤ 1,000	≤ 1,500
Micro-D		47pF - 22.5nF	≤ 680	≤ 1,020
Nano-D		47pF - 3.0nF	≤ 200	≤ 500
Combo-D		47pF - 6.0nF	≤ 800	≤ 1,200
Power-D		47pF - 6.0nF	≤ 680	≤ 1,020

Ask us about your specific requirements: <https://www.johansondielectrics.com/ceramic-capacitor-substrates>



Planars

Discoidal Capacitors Arrays

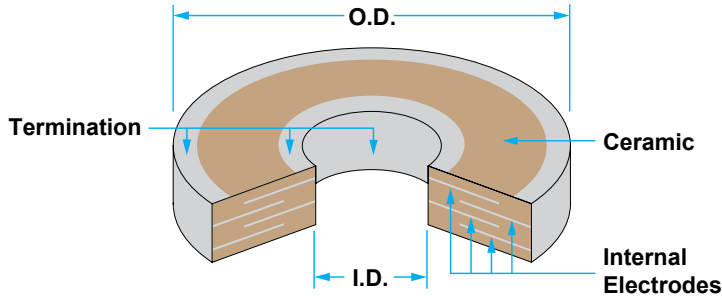

Contact Us . . .

Our engineers will assist you your unique design requirements.

Discoidal Capacitors - EMI Filter Products

Johanson Discoidal Feed-through Capacitors are the functional element in the popular and widely used EMI feed-through filters. Johanson Dielectrics Discoidal Capacitors are versatile in meeting varied customer voltage, capacitance and dimensional requirements. These multi-layer capacitors are nonpolar, small, reliable and high in dielectric strength. These devices have very low impedance in their ground paths as their design allows the signal many (up to 100) paths to ground. Discoidal capacitors are ideal for by-pass, filtering, coupling, single line EMI/RFI suppression, and high frequency applications.

- Robust construction, resist damage from handling
- Capacitance values from 10 pF to 11.2 μ F
- Test standards and procedures per MIL-STD-202 and MIL-C-123
- Voltage ratings from 50 to 3000 VDC and 50 to 240 VAC
- Low ESR and ESL, non-polar designs
- Nearly any outside/inside diameter combination, circular or square

While our discoidal product line is far too varied to list all available combinations, performance characteristics for some of our popular models. Call us to discuss your special requirements!

Example Nominal O.D. (")	Dielectric Material	Available Capacitance	Inside Diameter (")	Thickness (")	Rated Voltage
0.100 \pm .005	X7R, NP0 and Selected MOV	10pF - 66nF	10pF - 20 μ F	0.025 \pm 0.070	Up to 200 VDC
0.150 \pm .005		10pF - 200nF	0.037 \pm 0.058		
0.335 \pm .005		10pF - 2.8 μ F	0.034 \pm 0.088	0.045 \pm 0.110	Up to 500 VDC
0.345 \pm .005		10pF - 6.0 μ F	0.040 \pm 0.085	0.055 \pm 0.110	Up to 750 VDC
0.376 \pm .005		10pF - 8.0 μ F	0.050 \pm 0.075	0.065 \pm 0.125	
0.643 \pm .005		10pF - 15 μ F	0.063 \pm 0.080	0.055 \pm 0.150	
0.840 \pm .005		10pF - 20 μ F	0.050 \pm 0.075	0.080 \pm 0.130	Up to 1000 VDC

NOTE: MIL STD Screening Available



Substrates - Thin Film Patterned

Key Features:

- Quick turn prototype to high volume production.
- Advanced thin film manufacturing capabilities / features.
- Wide array of ceramic substrate materials / metal systems.
- Unique customer solutions.
- The ability to reduce circuit size and discrete components.

HIGH FREQUENCY CERAMIC SOLUTIONS

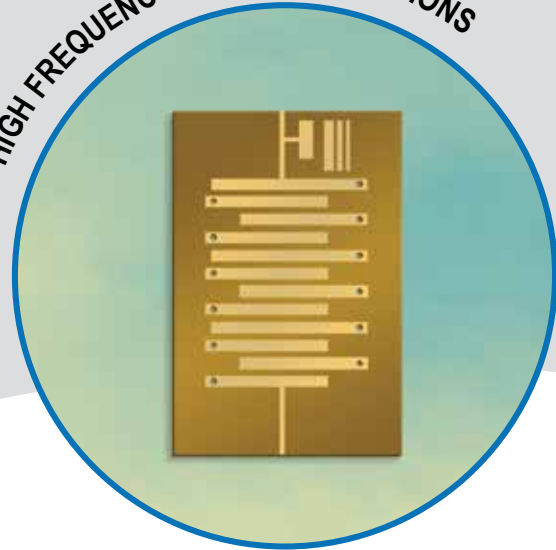

Substrate Selection

Choosing the correct substrate influences the mechanical and electrical function of a design. Johanson offers a wide range of dielectrics for use in application specific environments. These materials are available in lapped, polished, and “as fired” conditions. These substrates can be metallized or nonmetallized. Metallized substrates may be patterned to customer specifications by chemical etching, abrasive etching, and patterned plating.

Coefficient of thermal expansion (CTE) and thermal conductivity are important parameters for circuits involved with high power. Care should be used when choosing a substrate because differences in CTE values of close metals, like housings or heat-sinks, will cause mismatch stresses in an assembly during temperature changes. Thermal conductivity defines the rate of heat transfer between hot and cold regions of your design. In applications where heat conduction is critical, designers must consider thermal conductivity of available substrates or use filled-vias as an alternative thermal path within a design.



Substrates - Thin Film Patterned

Table 1: Material Electrical and Mechanical Properties

Substrate Material (Code)	Temperature Coefficient (-55 to +125°C)	Dielectric Constant	Tanθ 1KHz/ 1MHz*/ 10 GHz**	Dielectric Strength (V/mil)	Coefficient of Thermal Expansion (ppm/°K)	Thermal Conductivity (W/m²-K) @ 25°C/100°C*
Diamond (D)	----- Consult with Factory -----					
Quartz (Q)		4.5	0.0001**	>635	0.55	5/2
AlN (F)	170 W/m °K	8.8	0.0005*/0.002**	355	4.6	190min/160, 170min/130
Alumina (G)	P120 +/- 30ppm	9.9	0.0001*	450	7	26.6
Titanate (C)	0 ± 30ppm/°C	23	≤0.0015*	205	~ 9	1.55
Titanate (K)	0 ± 30 ppm/°C	39	≤0.0015*	205	~ 9	1.55
Titanate (N)	0 ± 30 ppm/°C	76	≤0.0015*	210	~ 9	1.55
Titanate (V)	-1500 + 500/-944 ppm/°C	160	≤0.0025*	220	~ 10	1.55
Titanate (R)	-2200 ± 500ppm/°C	440	≤0.0025*	150	N/A	N/A
Titanate (D)	± 10 %	725	≤0.025	175	N/A	N/A
Titanate (B)	± 10 %	1410	≤0.025	190	N/A	N/A
Titanate (W)	± 10%	2300	≤0.025	190	N/A	N/A
Titanate (X)	± 15%	3150	≤0.025	190	N/A	N/A
Titanate (T)	± 15%	4100	≤0.025	250	N/A	N/A

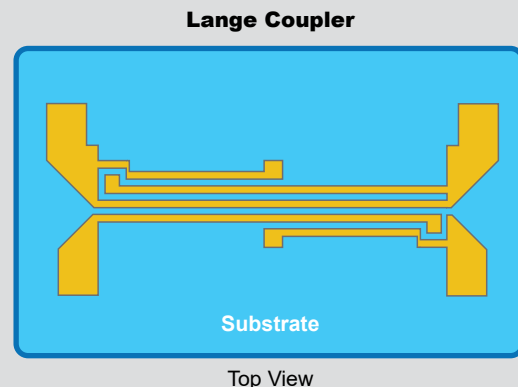
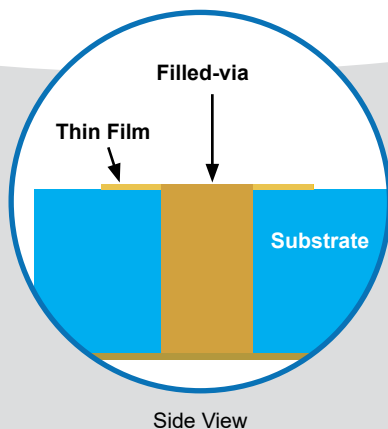



Substrates - Thin Film Patterned

Table 2: Standard Materials, Surface Finish, and Sizes

Substrate (Code)	Surface Finish (u-in)			Max L x W (in)	Standard Thickness (mils)
	As Fired	Lapped	Polished		
Diamond (D)	----- Consult with Factory -----				
Quartz (Q)					10 to 40
AlN (F)	20	20	3		5 to 40
Alumina (G)	20	20	3	4.8 x 4.8	5 to 60
Titanate (C)	30	10	3	1.5 x 1.5	5 to 15
Titanate (K)	30	10	3	1.5 x 1.5	5 to 15
Titanate (N)	30	10	3	1.5 x 1.5	5 to 15
Titanate (V)	30	10	3	1.5 x 1.5	5 to 15
Titanate (R)	30	10	3	1.5 x 1.5	5 to 15
Titanate (D)	50	10	3	1.5 x 1.5	5 to 15
Titanate (B)	50	10	3	1.5 x 1.5	5 to 15
Titanate (W)	50	10	3	1.5 x 1.5	5 to 15
Titanate (X)	50	10	3	1.5 x 1.5	5 to 15
Titanate (T)	50	10	3	1.5 x 1.5	5 to 15

- Standard substrate sizes range from .050" x .050" to 1.50" x 1.50"
- Larger sizes available for special requests.
- Typical operating temperatures for all available substrates is -55 to +125°C.

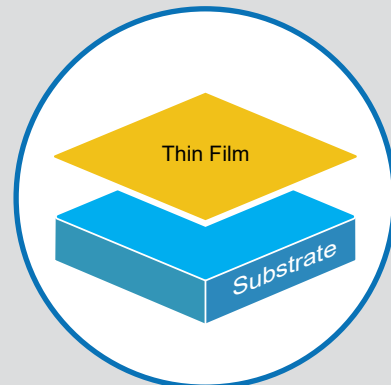



Substrates

Thin Film Patterned - Metals Selection

Johanson Technology offers several different metal schemes to meet customer needs. We offer single-sided or double-sided metallization. Each side can have unique design requirements and metallization. Each metal layer typically has a specific use, whether that be adhesion, barrier or conductor layers. Selection of a metal should be based on electrical functioning demands and/or requirements.

Some designs require pads suitable for solder attachment while others require metals that could readily be wire bonded. Solder-able metallization schemes are available by adding Ni or Cu barrier for thin film designs. For optimal wire bond integrity, Johanson recommends a minimum of 100µ” thickness on thin film designs, although good performance can be achieved with as low as 80µ”.

Careful selection of particular metallizations are dependent on requirements for solder-ability, temperature resistance, wire bonding, and electrical performance. Note: Johanson has capability to sputter and plate other metals not listed in Table 3. We will review special requests for metallizations not listed here.

Table 3: Available Plated Metals

Plated Metals	Metal Thickness (min/max)	Metal Thickness Tolerance	Typical Uses
Copper (Cu)	50-200µ” (1.27µm - 5.08µm)	± 50µ” (1.27µm)	Wire bond/Conductor
Gold (Au)	50-200µ” (1.27µm - 5.08µm)	± 50µ” (1.27µm)	Wire bond/Conductor
Nickel (Ni)	50-100µ” (1.27µm - 2.54µm)	± 25µ” (.635µm)	Barrier/solder attach

Table 4: Available Sputtered Metals

Sputtered Metals	Metal Thickness (min/max)	Metal Thickness Tolerance	Typical Uses
TiW (TiW)	200-500 Å	± 100Å	Barrier, adhesion
Nickel (Ni)	500-1,000 Å	± 250Å	Barrier, solder
Gold (Au)	1,000-2,000 Å	± 250Å	Wire bond/conductor
Platinum (Pt)	Å	± 100Å	Barrier, adhesion
Chromium (Cr)	250-750 Å	± 100Å	Barrier, adhesion
Silver (Ag)	500-1,000 Å	± 100Å	Conductor
Palladium (Pd)	750-2,000 Å	± 250Å	Barrier
Copper (Cu)	1,000-2,000 Å	± 250Å	Conductor



Substrates Thin Film Patterned - Conductor Traces

Precise management of critical geometric features lead to excellent and dependable performances in RF, microwave, and millimeter wave designs. With accurate conductor line widths and spacing, designers can control the characteristic impedance of transmission lines, coupling between RF traces, and even manage thermal loads within RF circuits. Using high quality conductor traces with little variation allows designers to have consistent performance in RF components such as filters and couplers.

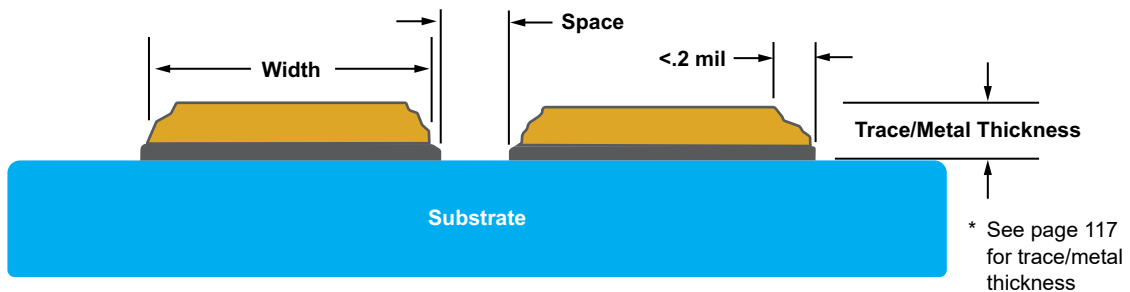
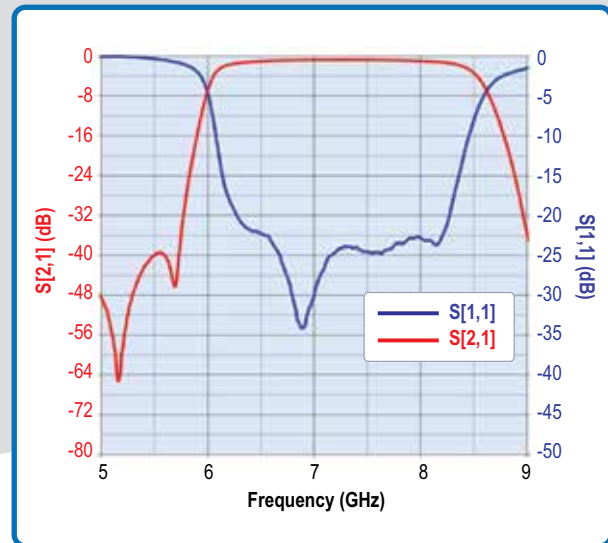

Conductor Trace Diagram

Johanson Technology's standard offering is the gold conductor trace. Other materials, like copper can be used in some instances.

Table 5: Standard Line Traces and Tolerances

Sputtered / Plated Metals			
Standard line width/space	.0010" (25.40µm)	Standard line width/space	.0010" (25.40µm)
Standard line width/space tolerance	.0002" (5.08µm)	Line width/space tolerance	.0002" (5.08µm)
Min. line width/space	.0005" (12.70µm)		
Min. line width/space tolerance	.0001" (2.54µm)		



Substrates

Thin Film Patterned - Designing With Vias

Johanson has advanced experience incorporating vias into substrate designs with demanding requirements. Vias can be offered as either filled, through-hole or plated-through. Engineers must review the existing electrical and thermal properties of their design before deciding between filled or plated-through vias. The overall process is completed by lasering through a substrate from the top to bottom layer and then sputtering or plating over the substrate via opening. Both via options are effective in routing electrical signals from one side to another.

Plated-through vias are often recommended for low-power applications or in designs that require an opening to be maintained. In contrast, filled-vias are best used in high power applications or to enhance thermal properties of the hybrid design. Filled-vias are useful in keeping heat away from the substrate, which in turn helps to prevent defects or circuit failures. Filled-vias offer the lowest RF inductance and thermal resistance. Laser machined vias have a taper equal to approximately 10% of the material thickness.

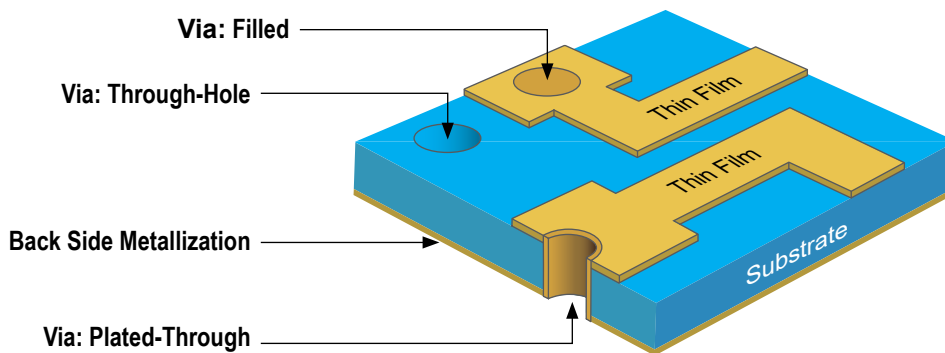

Table 6: Via Features

Dimension	Plated	Filled	Through Hole
Substrate Thickness	0.005"-0.035" (0.127-0.889mm)	0.005"-0.035" (0.127-0.889mm)	0.005"-0.035" (0.127-0.889mm)
Min. Via Diameter	60% of Substrate Thickness	60% of Substrate Thickness	60% of Substrate Thickness
Via Positional Tolerance	±0.002" (0.051mm)	±0.002" (0.051mm)	±0.002" (0.051mm)
Via Diameter Tolerance	±0.002" (0.051mm)	±0.002" (0.051mm)	±0.002" (0.051mm)
Min. Via Center to Center	1x Diameter	1x Diameter	1x Diameter
Min. Via Spacing Center to Edge	1x Diameter	1x Diameter	1x Diameter
Via Taper	10% of Substrate Thickness	10% of Substrate Thickness	10% of Substrate Thickness



Substrates

Thin Film Patterned - Laser Machining

Laser machining is available to provide designers with controlled hole locations, custom shapes and sizes, and superb edge accuracy. Johanson's team allows engineers to realize flexible designs within the ceramic substrates. Johanson's standard laser features and tolerances can be visualized below.

Table 7: Laser Machining

Dimension	Lasered
Substrate Thickness	0.005"-0.035" (0.127-0.889mm)
Diced Edges Tolerance	±0.002" (0.051mm)
Min. Metal To Edge Pullback Spacing	0.002" (0.051mm)
Min. Cutout Radius	0.006" (0.152mm)
Laser Cutout Tolerance	±0.002" (0.051mm)
Laser Cutout Positional Tolerance	±0.002" (0.051mm)
Min. Cutout to Cutout Spacing	0.050" (1.27mm)
Min. Annular Ring (Metallized Cutout)	0.0025" (0.064mm)
Lasered Taper	10% of Substrate Thickness

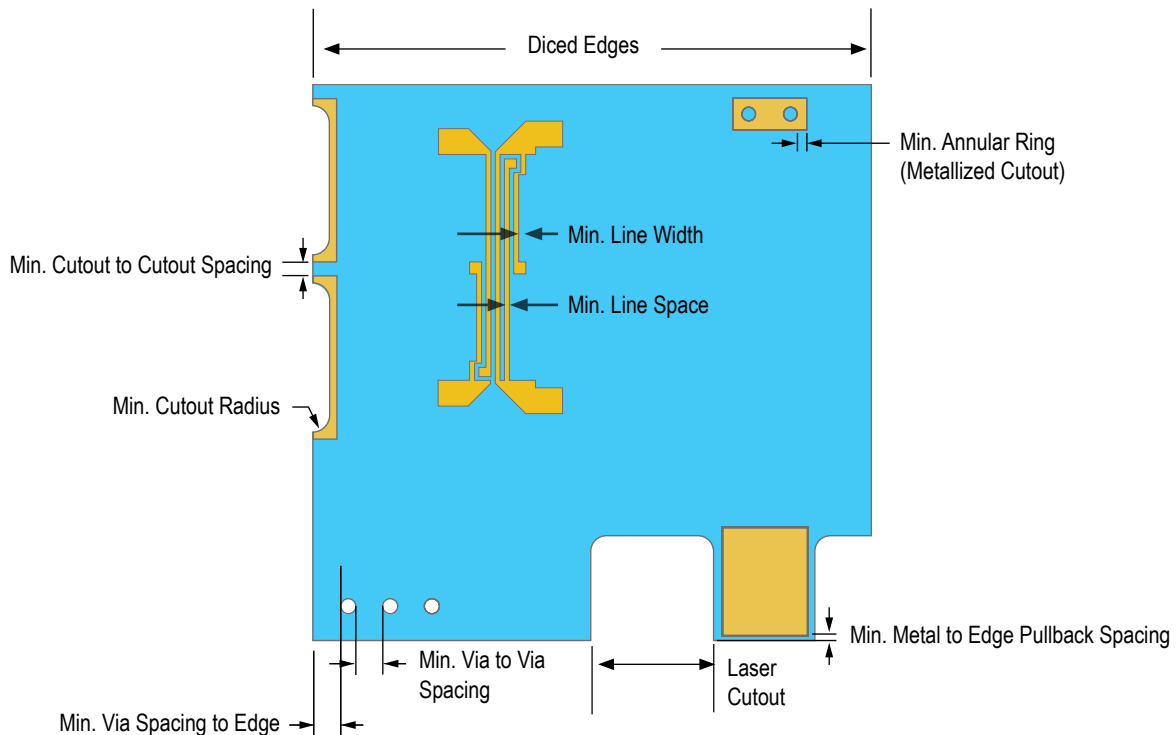





Substrates

Thin Film Patterned - Inspection & Quality Commitments

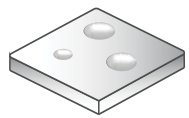
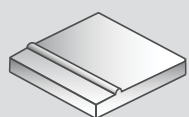
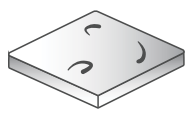
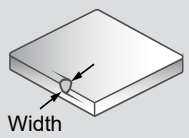
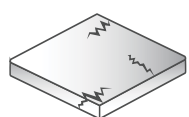
Table 8: Visual Inspection Criteria for Unmetallized Substrates

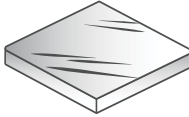
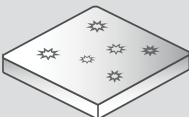
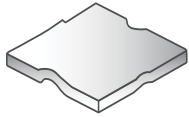
Attribute	Definition of Visual Attribute	Diagram	Acceptable Conditions
Blister	Formation of small to large, broken, or unbroken bubbles.		Smooth no blisters.
Bumps, Fins, and Ridges	Streak of excess material.		Smooth no bumps, fins, or ridges.
Burrs	A raised edge or fragment of external material on the surface.		Height less than 1 millimeters and diameter less than 10 millimeters.
Chips	Visual evidence remaining on the substrate indicative of material loss from corners or edges due to mechanical damage, lack of material integrity, or both.		Less than 10 millimeters.
Cracks	Line on the surface which has split without breaking apart.		Solid no cracks.
Pits, Holes, and Pocks	A cavity or void.		Diameter less than 5 millimeters.
Scratches	A long, thin, or small gash/cut on the plane.		Less than 2 millimeters deep and less than 25 millimeters length.
Snowflakes	Microscopic metallic residue on X-dielectric surfaces.		Smooth no bumps, fins, or ridges.
Warpage	Substrate deformed or misshapen.		Height variation less than 10 millimeters per 100 millimeters in length.



Substrates

Thin Film Patterned - Design Submissions

"We encourage all designers to submit their drawings or ideas for quick and easy feedback."

How to Submit Custom Thin Film Designs. . .

Our outstanding, experienced technical team can provide feedback on reproducibility and help with custom layout design from concept stage to completion.

Before submitting your design, use the "preferred practices" checklist:

- Follow Johanson's design guidelines and standard specifications
- Provide CAD data in multiple layers
- Identify "A" side and "B" side for double-patterned circuits
- Provide tolerances and annotation
- DWG, DXF, Gerbers, and STEP files are preferred

Information needed:

- **Substrate:** Material, surface finish, thickness, and dimensions
- **Metallizations:** Thickness and tolerances
- **Conductor traces:** Type, spacing, and tolerances
- **Other:** Inspection or acceptance criteria

Resources:

Technical Questions

johansontechnology.com/ask-a-question

RoHS Compliance

johansontechnology.com/rohs-compliance

MSL Rating

johansontechnology.com/msl-rating

HIGH FREQUENCY CERAMIC SOLUTIONS



Antennas

Integrated Passive Components:

- Filters: Band Pass, Low Pass, & High Pass
- Baluns
- Couplers
- Power Couplers
- Diplexers & Triplexers
- Power Dividers



High-Q Capacitors



RF Assemblies



Single Layer Capacitors



Thin Film Substrates



RF Inductors: Ceramic and Wirewound

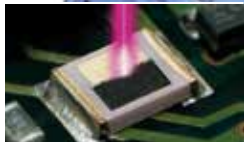

LASERtrim® Tuning Capacitors

POWER

ELECTRONIC SOLUTIONS



AC Safety



High Voltage



EMI X2Y Filters



Switchmode® Capacitor



Radial Leaded



Planar Arrays



Discoidals



AC Power



CapStrate® Capacitor Substrates



Variable Pitch Capacitors



High Temperature